



*Shopfitters by passion*

**vizona**

Technical instruction

# Technical instruction

August 2024



# Sales Desk

- **ST-I-OPL01A**
- **8007681**

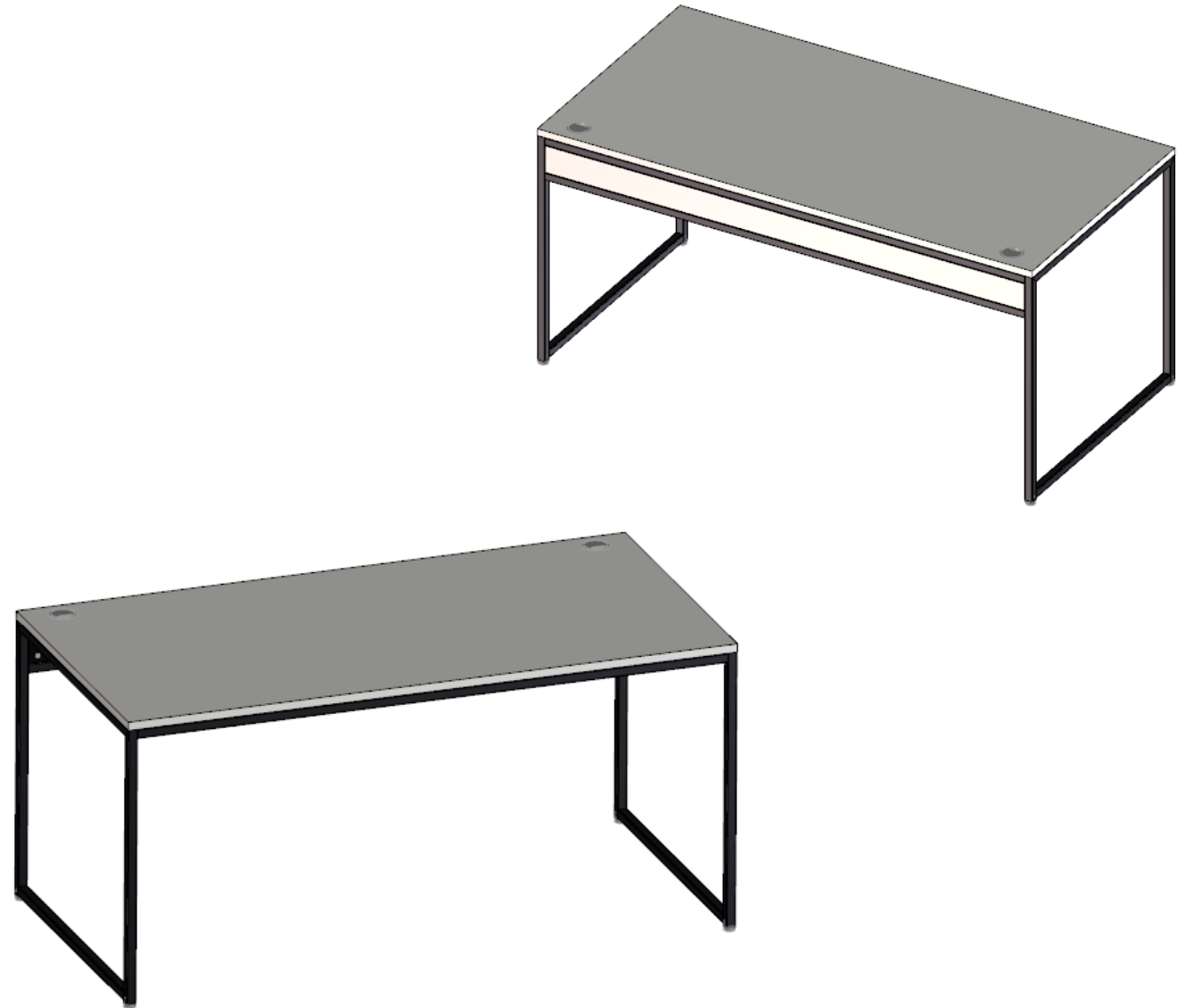

Dimensions : 1600x800x760

Weight : 45 Kg

Electrical connection : None

Mounting position : Middle space

# Sales Desk

## Requirements before installation

- The area must be accessible with a pallet truck (or equivalent).

## to observe

- Supply cable, power strip etc. not included.

## Explanation of symbols

 Compartment for power strip

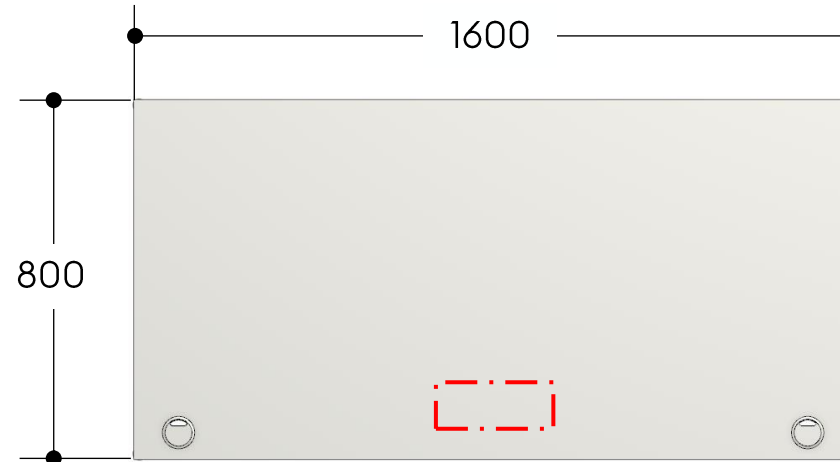
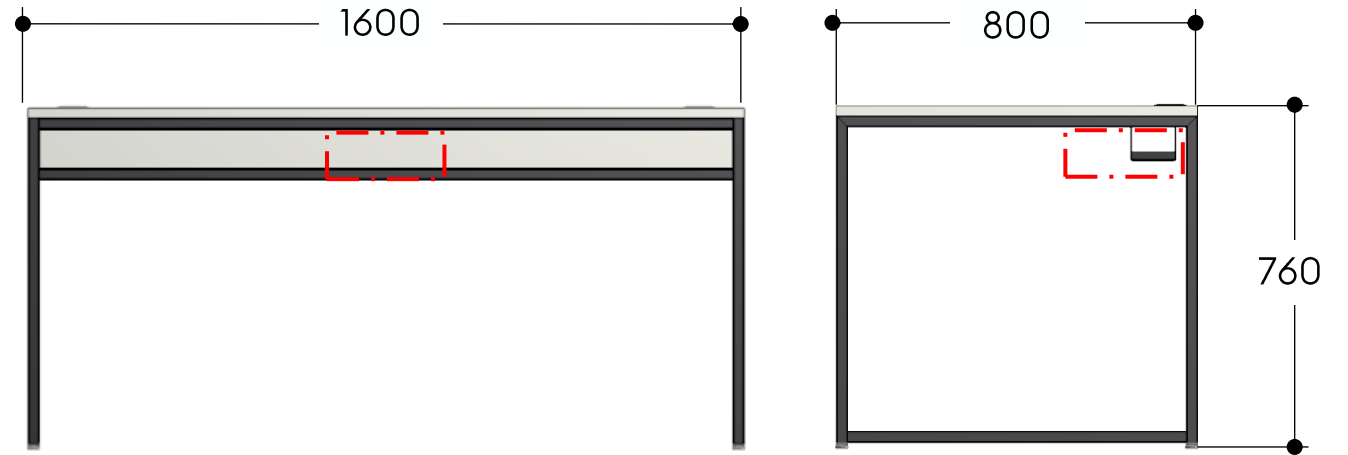

# Lamp Muuto Tip

- **ST-I-OPL01E**
- **83033570**

Dimensions : 160x400x295 (Ø160)

Weight : 1,6 Kg

Electrical connection : Ready to plug in

Mounting position : Table lamp



# Configurator Wall

- **ST-I-OPL02A**
- **8005021**
- **ST-I-OPL02A-G Kit Graphics**
- **8005049**

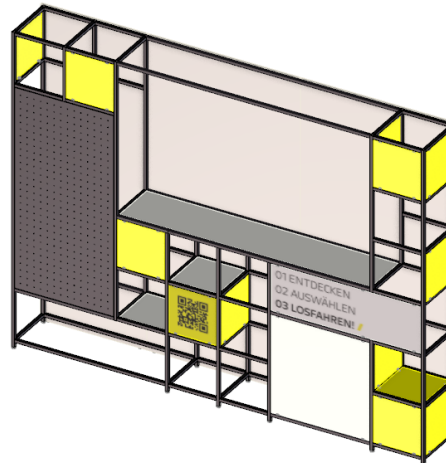
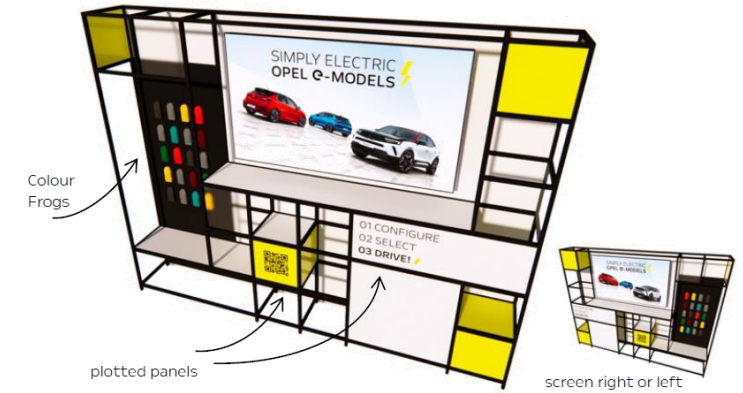
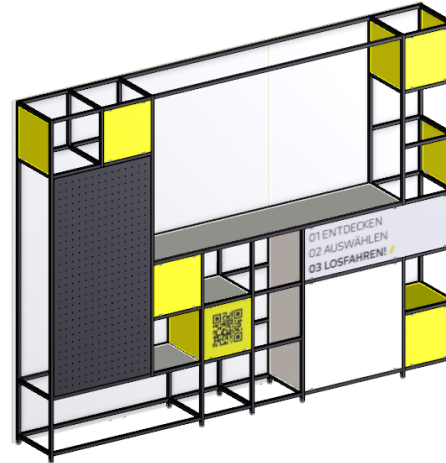

Dimensions : 3265x445x2475

Weight : 260 Kg

Electrical connection : None

Mounting position : Wall / middle space

# Configurator Wall

## Requirements before installation

- The area must be accessible with a pallet truck (or equivalent).
- The Configurator Wall is free-standing, is not fixed to the wall and can be positioned on the wall or in the middle of the room.

## to observe

- Supply cable, power strip etc. are not included in the scope of delivery.
- Monitor and monitor holder are not included in the scope of delivery.
- The inspection panel or the power supply for the monitor is manufactured during installation (on site).

## Explanation of symbols

 Inspection panel / power supply

 Wall / floor socket

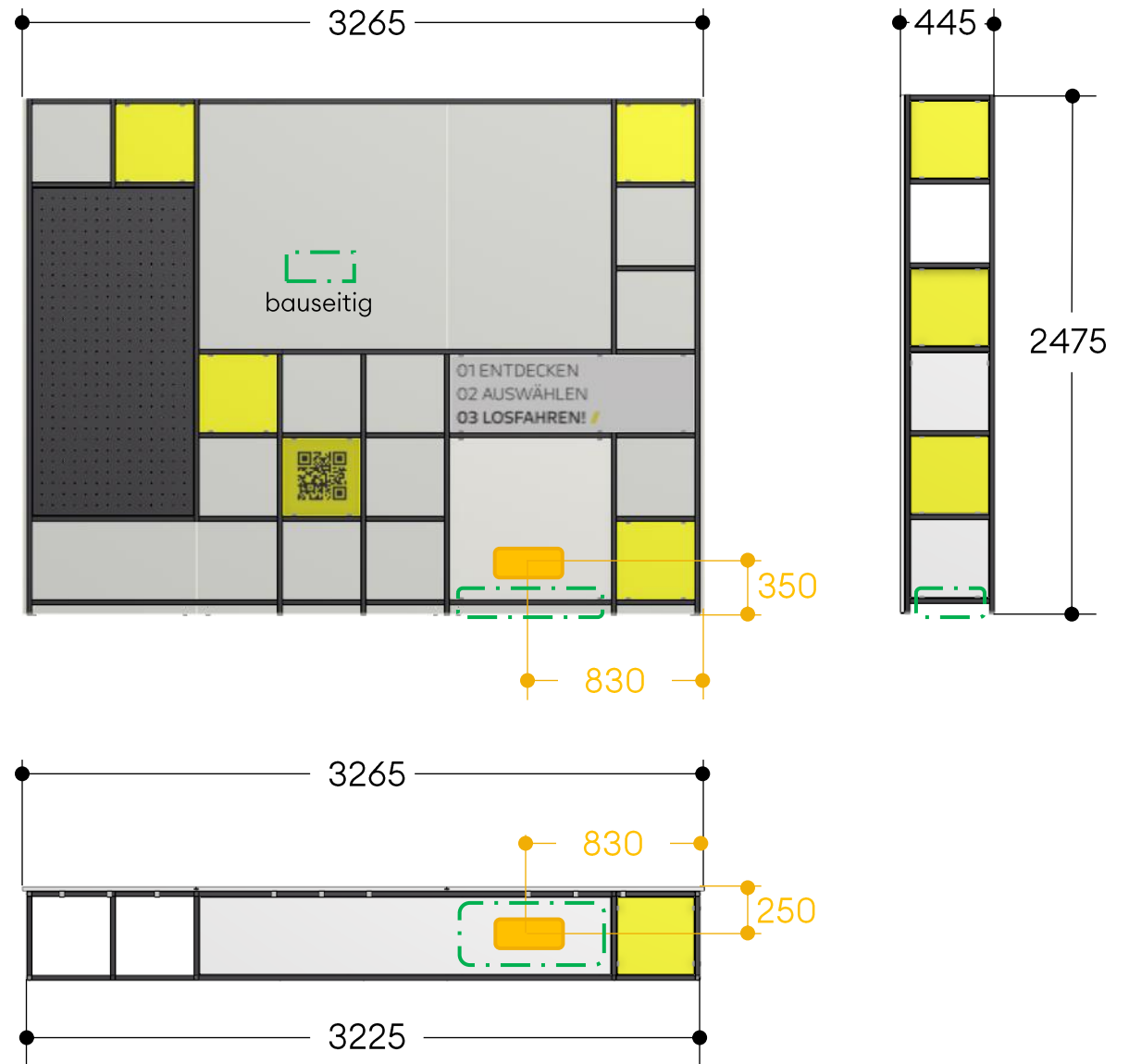

# Electric Corner Module LH

- **ST-I-OPL02B1**
- **8005051**
- **ST-I-OPL02B-G Kit Graphics**
- **8005052**

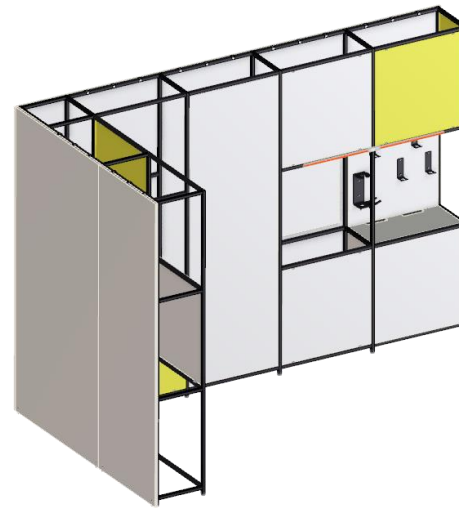
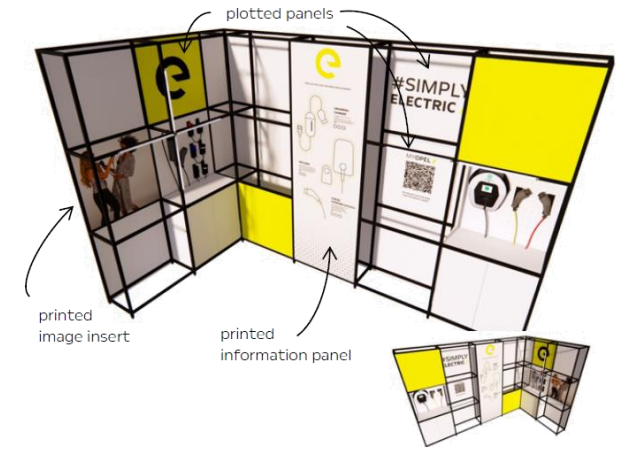
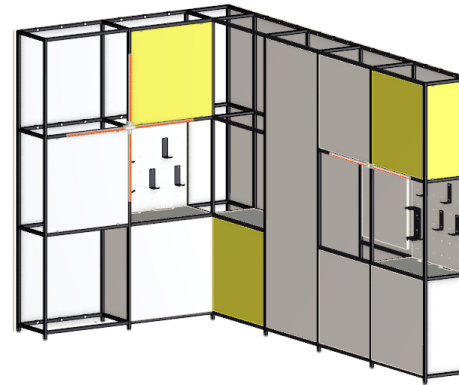

Dimensions : 3665x2065x2475

Weight : 470 Kg

Electrical connection : 1 x 230V

Mounting position : Wall / middle space



# Electric Corner Module LH

## Requirements before installation

- The area must be accessible with a pallet truck (or equivalent).
- The Electric Corner Module LH is free-standing, is not fixed to the wall and can be installed on the wall or in the middle of the room.

## to observe

- Supply cable, power strip etc. are not included in the scope of delivery.

## Explanation of symbols

-  Inspection panel / power supply
-  Wall / floor socket (2 options each)

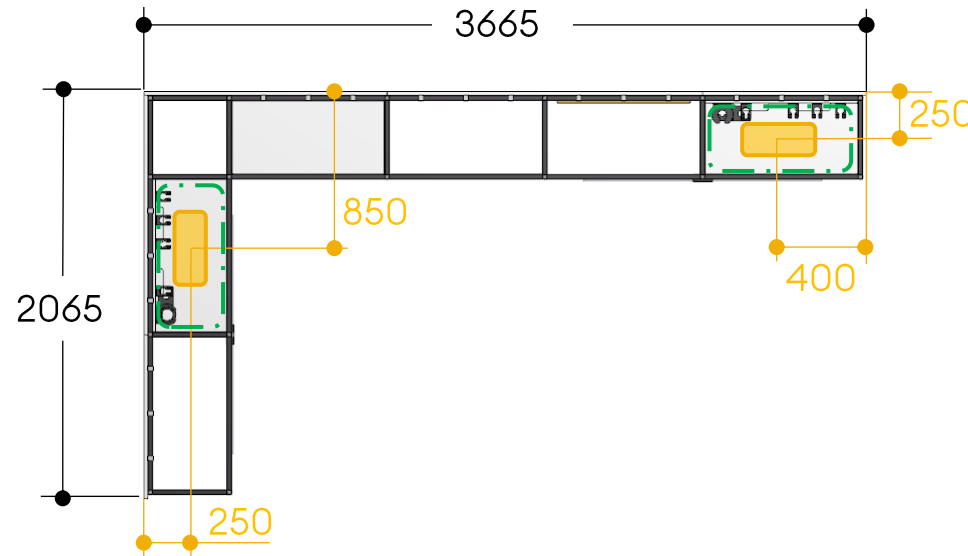
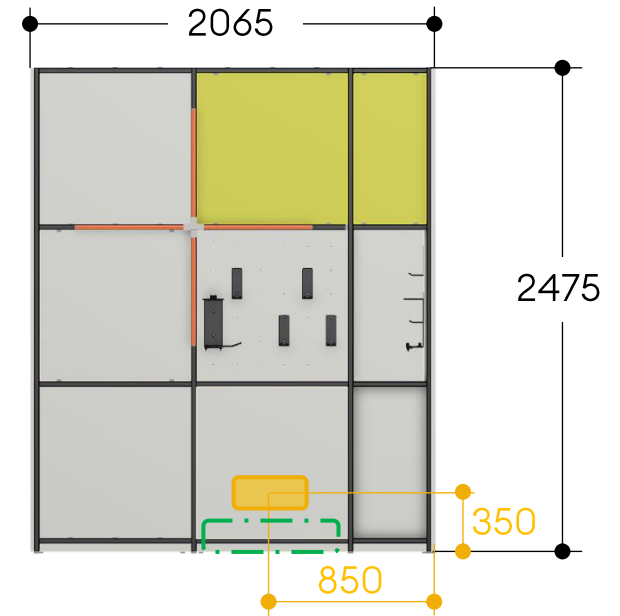
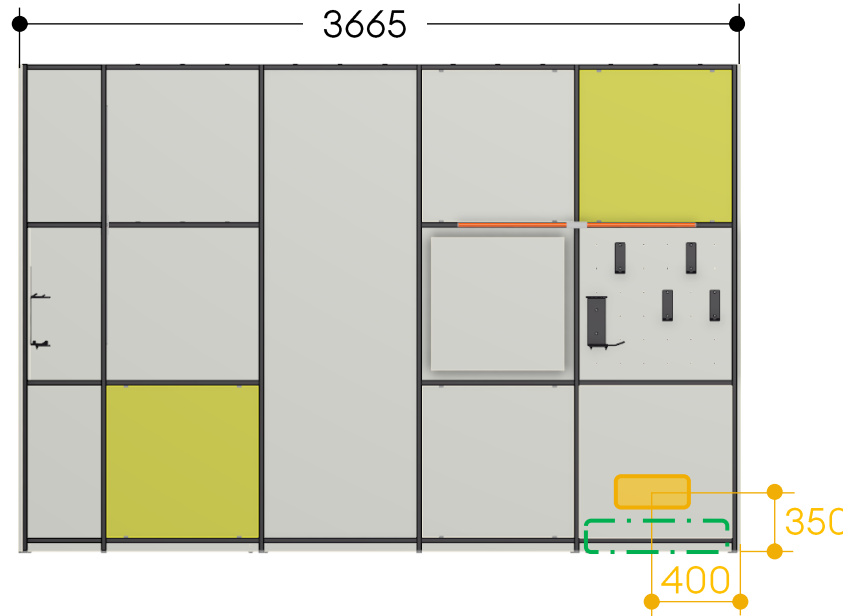

# Electric Corner Module RH

- **ST-I-OPL02B2**
- **8005077**
- **ST-I-OPL02B-G Kit Graphics**
- **8005052**

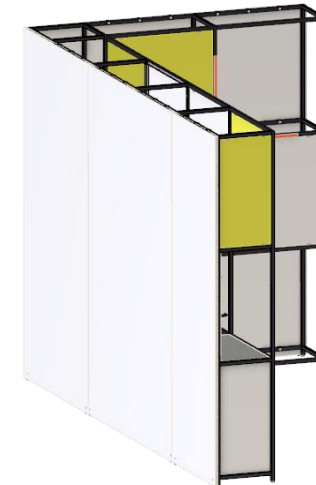
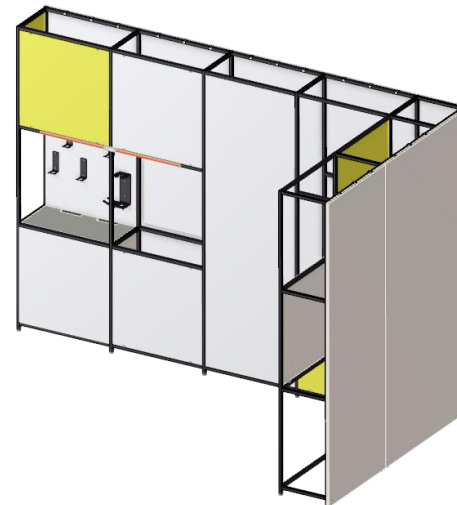
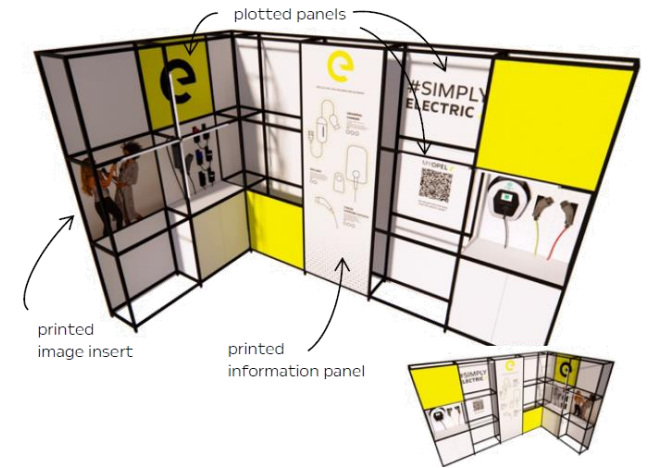
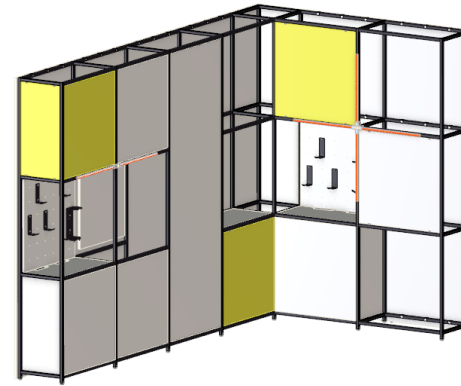

Dimensions : 3665x2065x2475

Weight : 470 Kg

Electrical connection : 1 x 230V

Mounting position : Wall / middle space

# Electric Corner Module RH

## Requirements before installation

- The area must be accessible with a pallet truck (or equivalent).
- The Electric Corner Module LH is free-standing, is not fixed to the wall and can be installed on the wall or in the middle of the room.

## to observe

- Supply cable, power strip etc. are not included in the scope of delivery.

## Explanation of symbols

-  Inspection panel / power supply
-  Wall / floor socket (2 options each)



# Electric corner module straight

- **ST-I-OPL02A**
- **8008072**
- **ST-I-OPL02B-G Kit Graphics**
- **8008073**

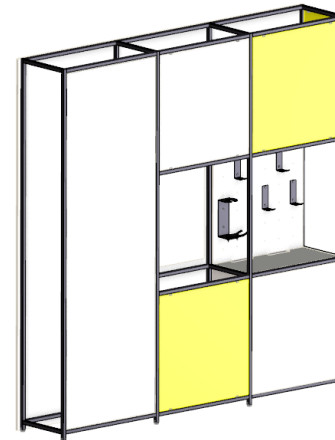
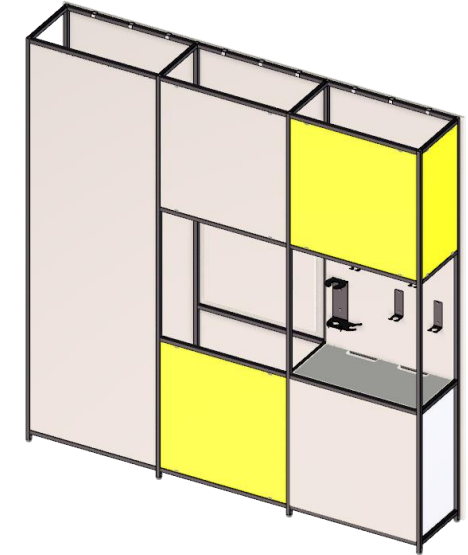
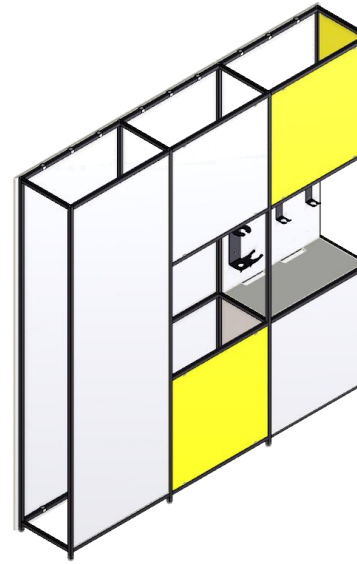

Dimensions : 2465x445x2475

Weight : 215 Kg

Electrical connection : None

Mounting position : Wall / middle space

# Electric corner module straight



## Requirements before installation

- The area must be accessible with a pallet truck (or equivalent).
- The Electric Corner Module LH is free-standing, is not fixed to the wall and can be installed on the wall or in the middle of the room.

## to observe

- Supply cable, power strip etc. are not included in the scope of delivery.

## Explanation of symbols

-  Inspection panel / power supply
-  Wall / floor socket (2 options each)



# Ceiling Frame Light (12 tiles)

- **ST-I-OPL02K1**
- **8005079**

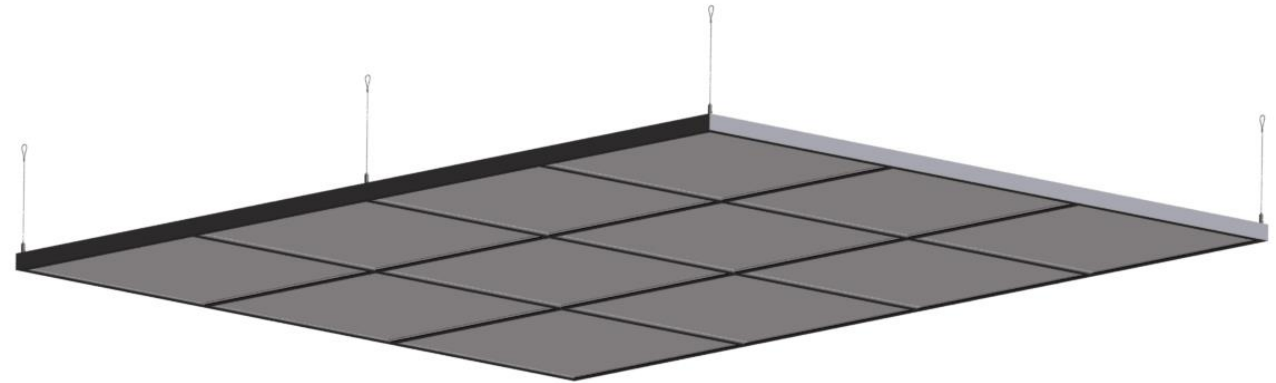

Dimensions : 2426x1820x40

Weight : 30 Kg

Electrical connection : 230 V

Mounting position : Ceiling

# Ceiling Frame Light (12 tiles)

## Requirements before installation

- The ceiling must be reinforced according to the weight specification of the article.
- On-site 230V supply cable coming from the ceiling is possible at each of the suspensions or in the middle of the Light Box.
- Each suspension point must be able to bear a load of at least 20 kg.

## to observe

- module is visible from above. A facing is recommended for multi-storey showrooms. This is not included in the costs.
- Supply cable, power strip etc. are not included in the scope of delivery.

## Explanation of symbols

- ⊕ Electrical connection: 230 V
- Ceiling fixing points
- ⌈⋮⌋ Ceiling reinforcement

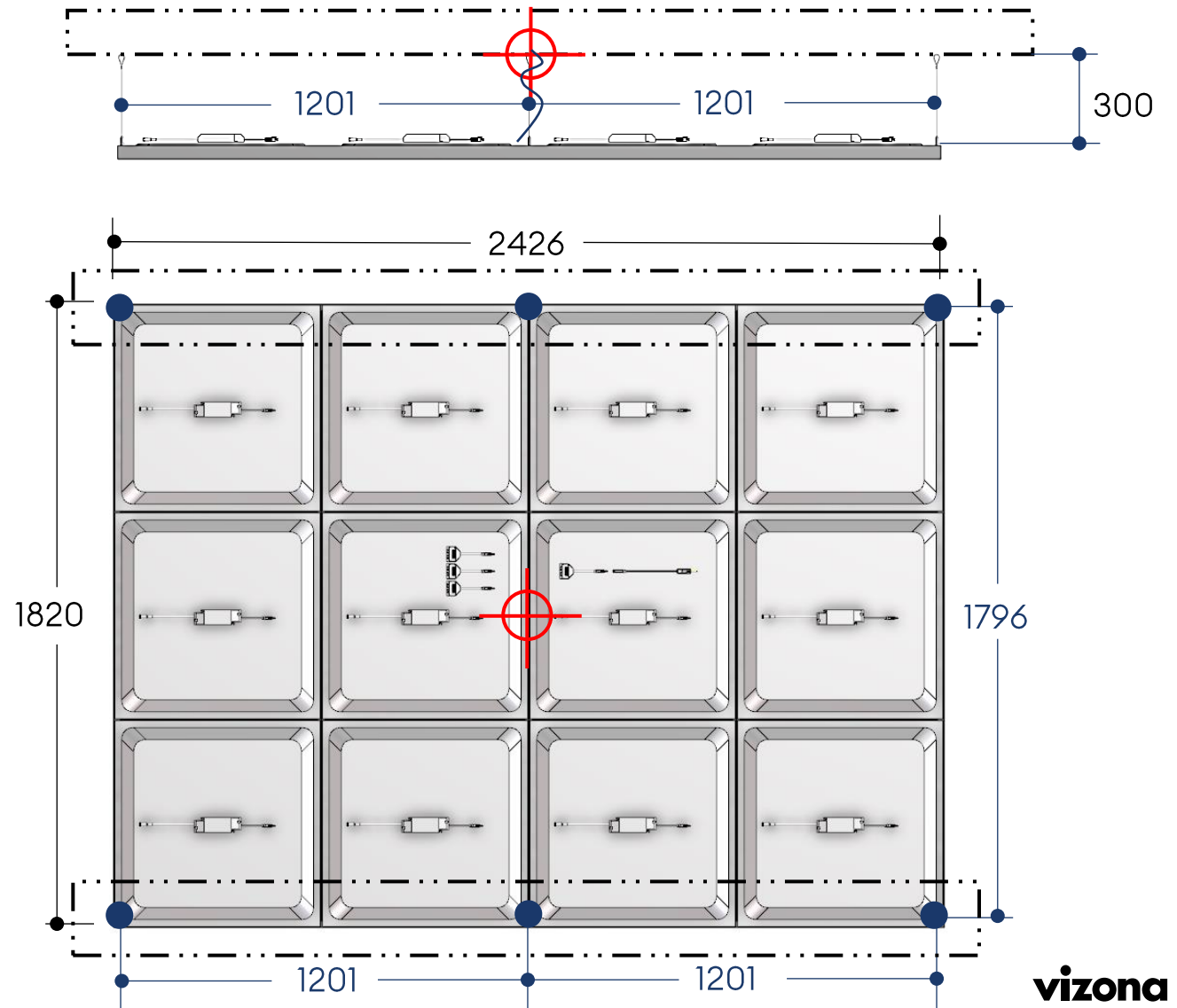

# TV Module

- **ST-I-OPL03D**
- **8000829**

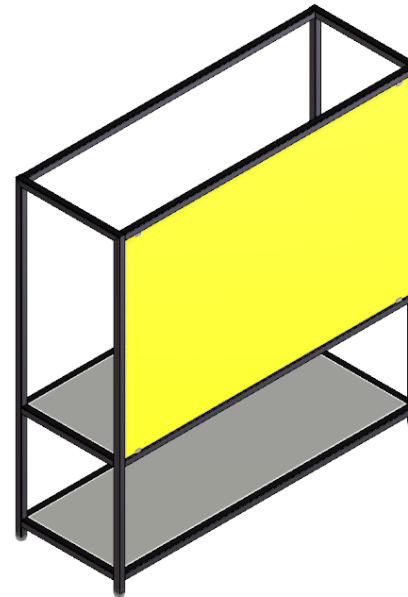
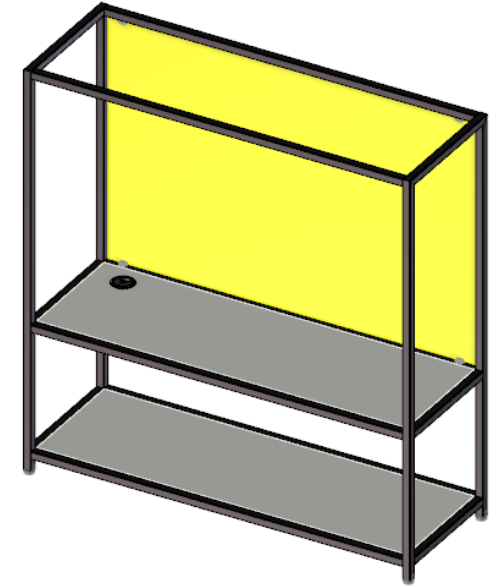
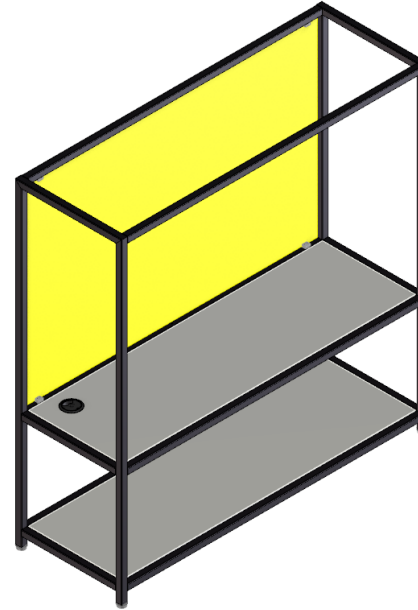

Dimensions : 1225x425x1275

Weight : 40 Kg

Electrical connection : None

Mounting position : Wall / middle space



# TV Module

## Requirements before installation

- Requirements before installationThe surface must be accessible with a pallet truck (or equivalent).
- The furniture is free-standing.

## to observe

- Supply cable, power strip etc. are not included in the scope of delivery.
- Monitor and monitor holder are not included in the scope of delivery.

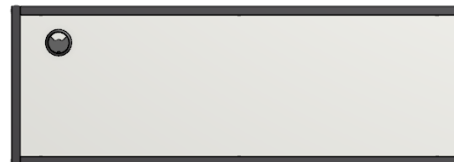
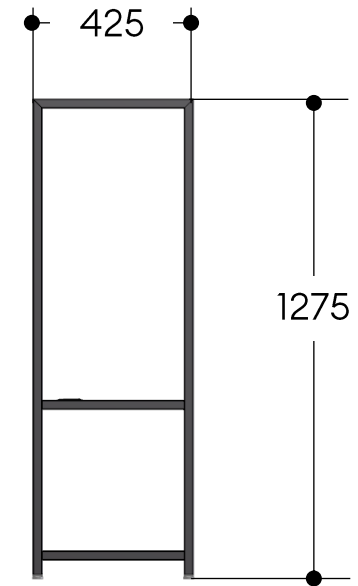
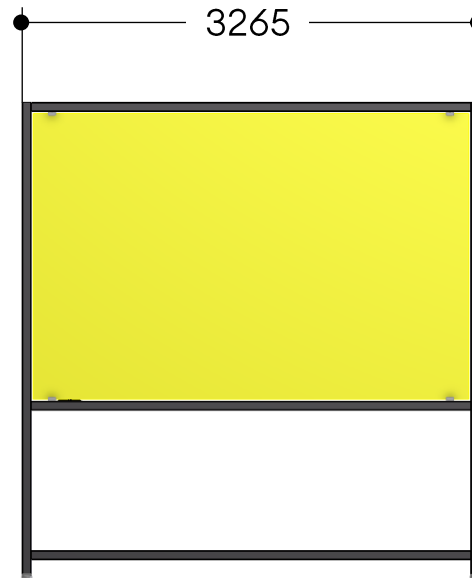

# Yellow Path

## Yellow Slash

- ST-I-OPL05A Yellow Slash S 8004870
- ST-I-OPL05B Yellow Slash M 8004868
- ST-I-OPL05C Yellow Slash L 8000469

SIZE XS

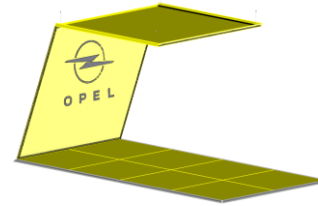

ST-I-OPL05D4 Yellow Ceiling Module XS

ST-I-OPL05A Yellow Slash S

ST-I-OPL05F4 Yellow Podest XS

## Yellow Ceiling Module

- ST-I-OPL05D1 Yellow Ceiling Module L 8004910
- ST-I-OPL05D2 Yellow Ceiling Module M 8006084
- ST-I-OPL05D3 Yellow Ceiling Module S 8006064
- ST-I-OPL05D4 Yellow Ceiling Module XS 8006077

SIZE S

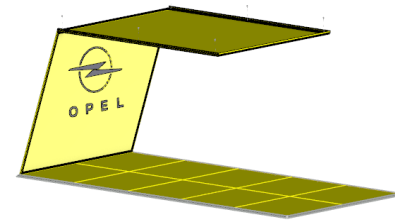

ST-I-OPL05D3 Yellow Ceiling Module S

ST-I-OPL05A Yellow Slash S

ST-I-OPL05F3 Yellow Podest S

SIZE M

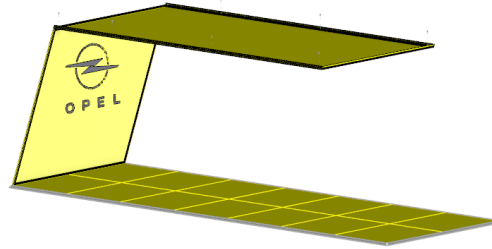

ST-I-OPL05D2 Yellow Ceiling Module M

ST-I-OPL05B Yellow Slash M

ST-I-OPL05F2 Yellow Podest M

## Yellow Podest

- ST-I-OPL05F1 Yellow Podest L 8003867
- ST-I-OPL05F2 Yellow Podest M 8003868
- ST-I-OPL05F3 Yellow Podest S 8003869
- ST-I-OPL05F4 Yellow Podest XS 8006871

SIZE L

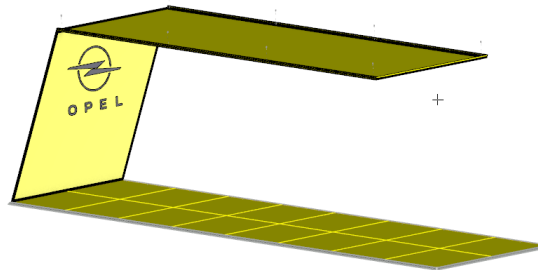

ST-I-OPL05D1 Yellow Ceiling Module L

ST-I-OPL05C Yellow Slash L

ST-I-OPL05F1 Yellow Podest L

# Yellow Path

## Systemüberblick

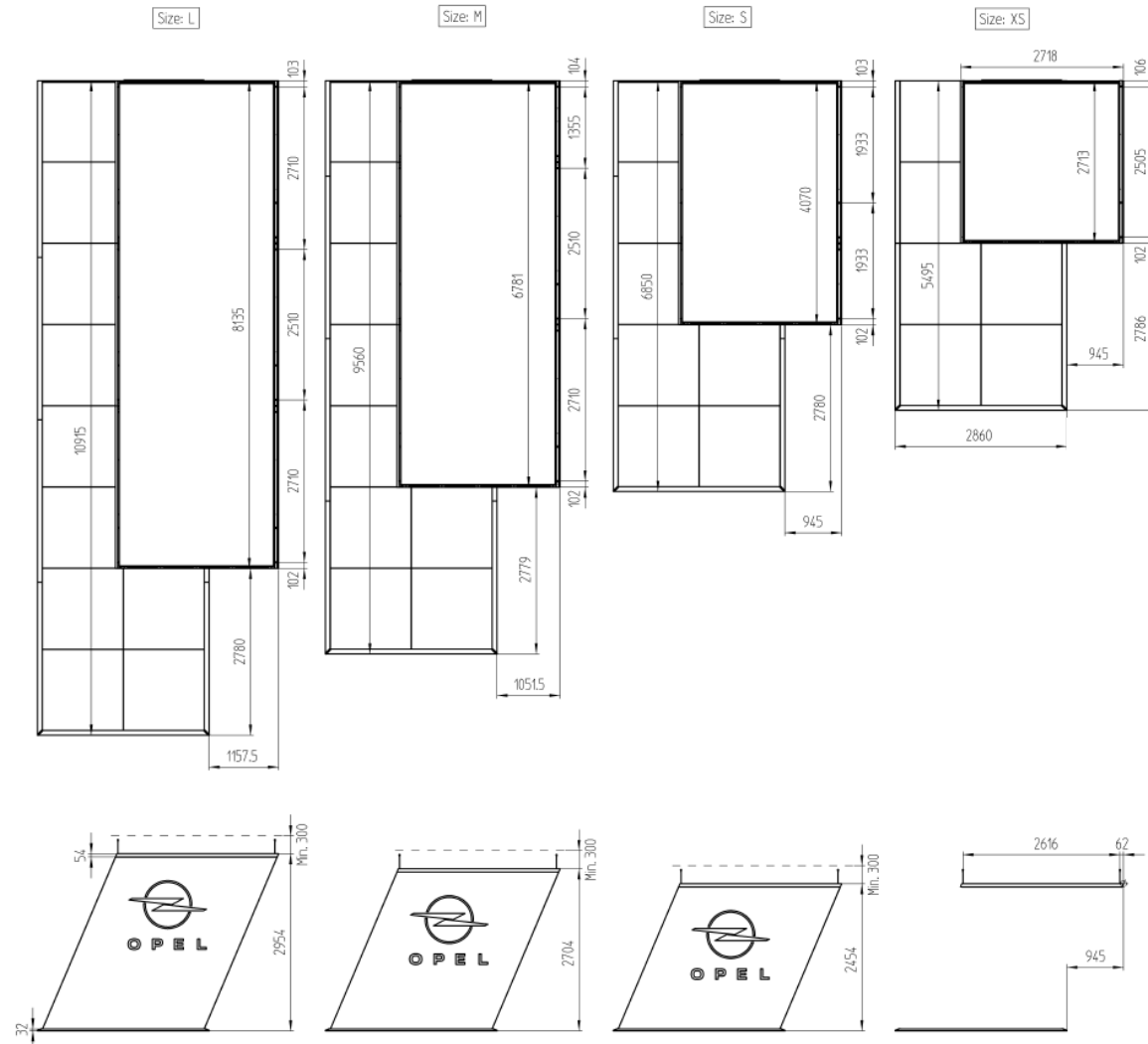

# Yellow Slash S

- **ST-I-OPL05A**
- **8004870**

Dimensions : H-2500mm

Weight : 27 Kg

Electrical connection : None

Mounting position : Wall

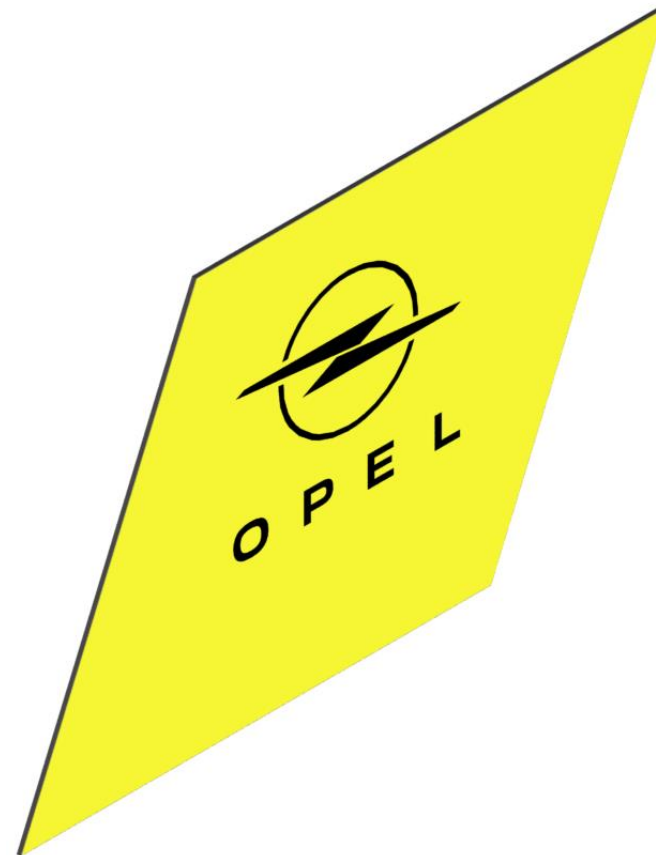

# Yellow Slash S

## Requirements before installation

- The wall must be reinforced according to the weight specification of the article.

## to observe

- Positioning Pedestal modules, Slash and Ceilling modules are interdependent.
- Wall opaque

## Explanation of symbols

 Wall reinforcement

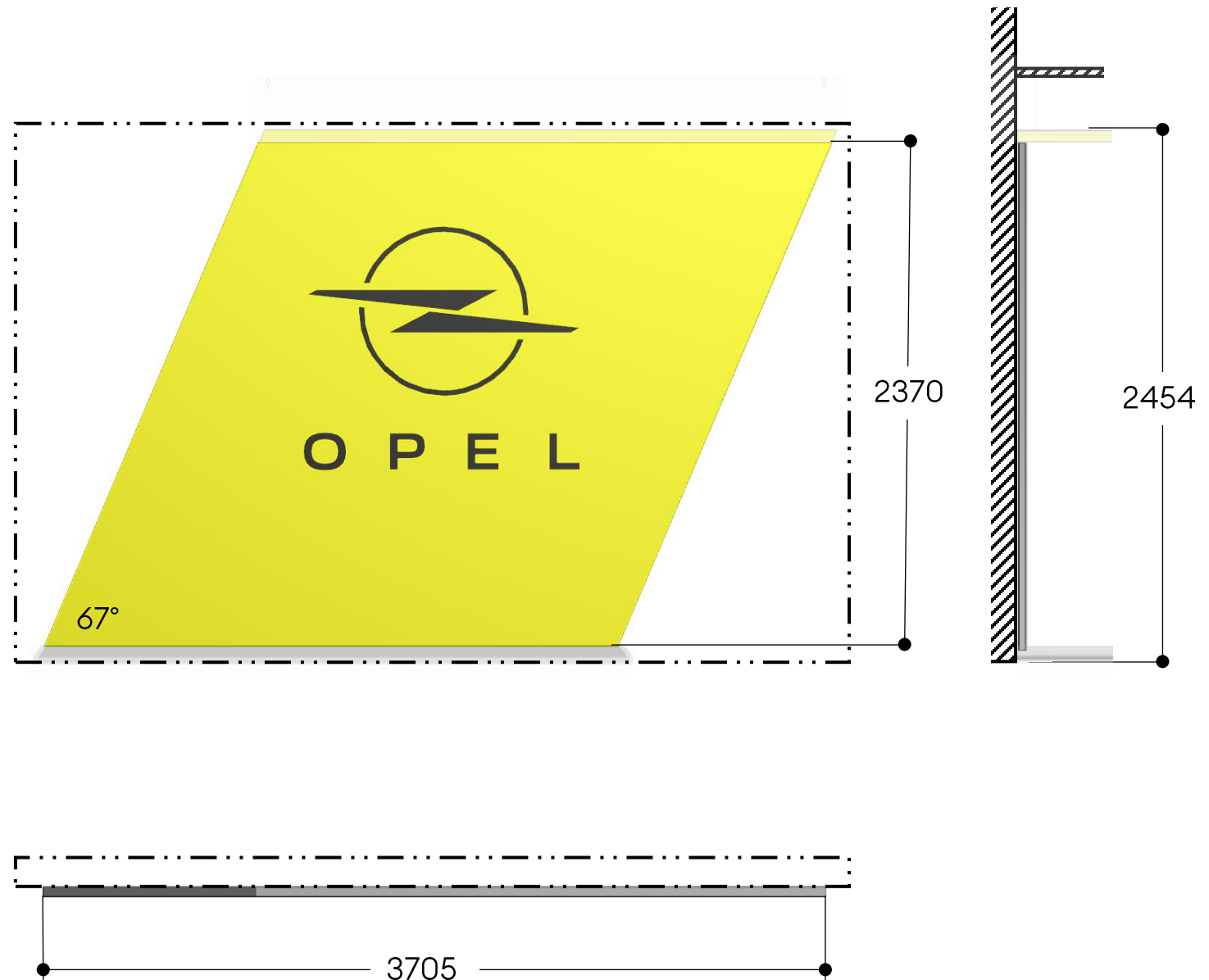

# Yellow Slash M

- **ST-I-OPL05B**
- **8004868**

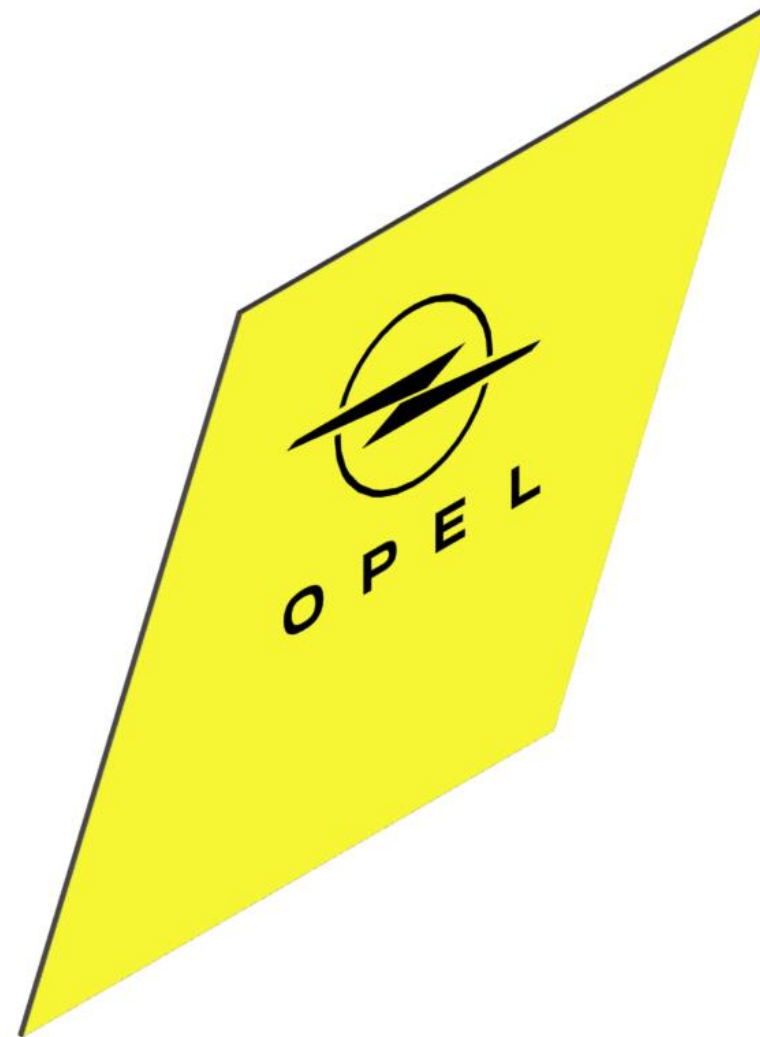

Dimensions : H-2750mm  
Weight : 30 Kg  
Electrical connection : None  
Mounting position : Wall

# Yellow Slash M

## Requirements before installation

- The wall must be reinforced according to the weight specification of the article.

## to observe

- Positioning Pedestal modules, Slash and Ceilling modules are interdependent.
- Wall opaque

## Explanation of symbols

 Wall reinforcement

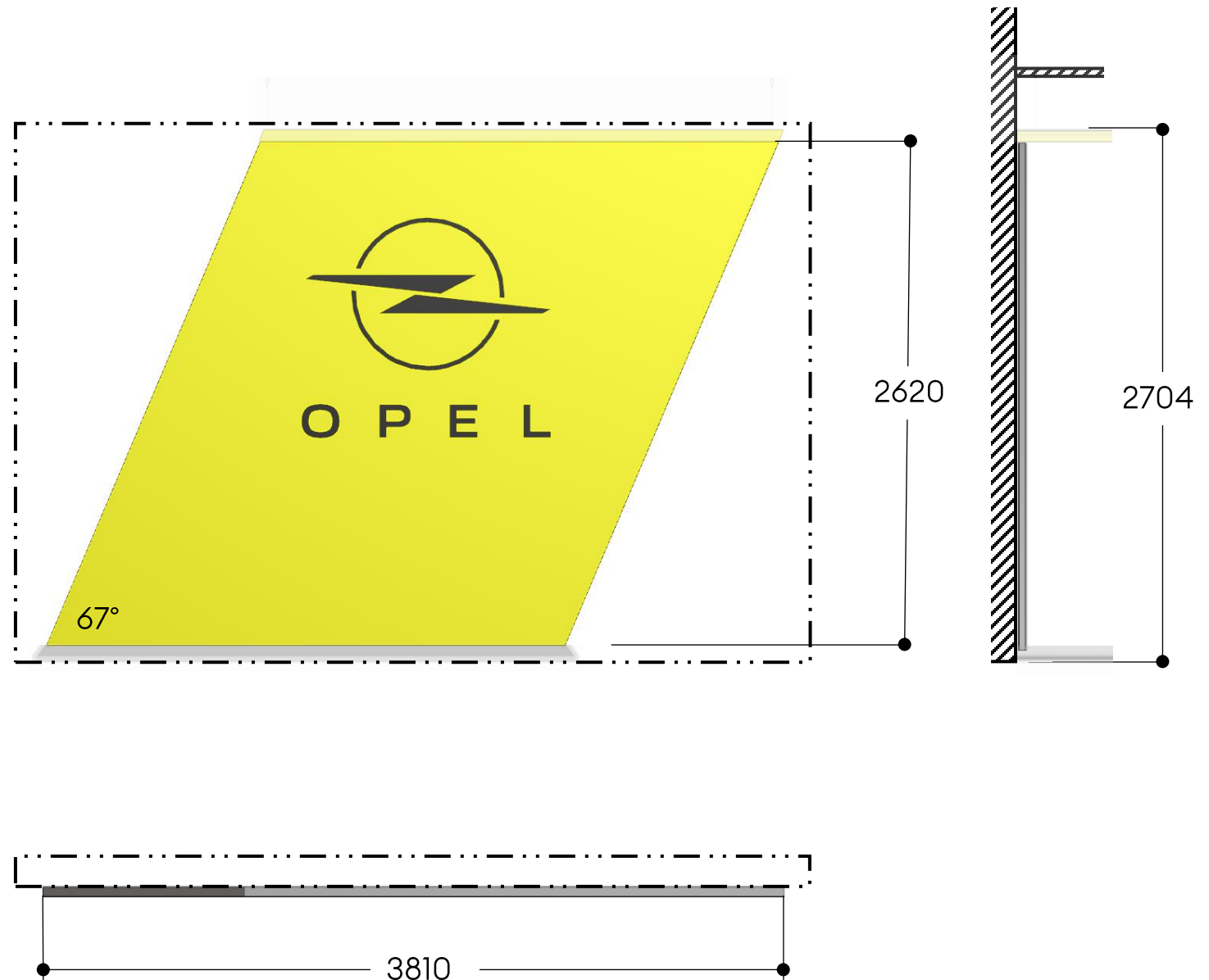

# Yellow Slash L

- **ST-I-OPL05C**
- **8000469**

Dimensions : H-3000mm

Weight : 40 Kg

Electrical connection : None

Mounting position : Wall

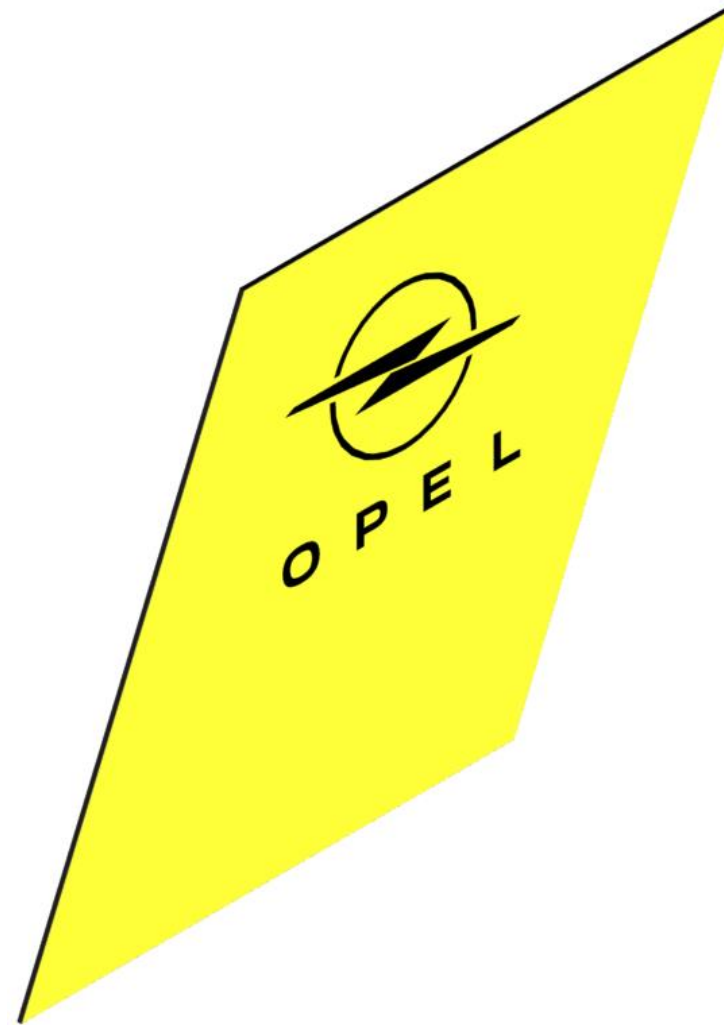



# Yellow Slash L

## Requirements before installation

- The wall must be reinforced according to the weight specification of the article.

## to observe

- Positioning Pedestal modules, Slash and Ceilling modules are interdependent.
- Wall opaque

## Explanation of symbols

 Wall reinforcement

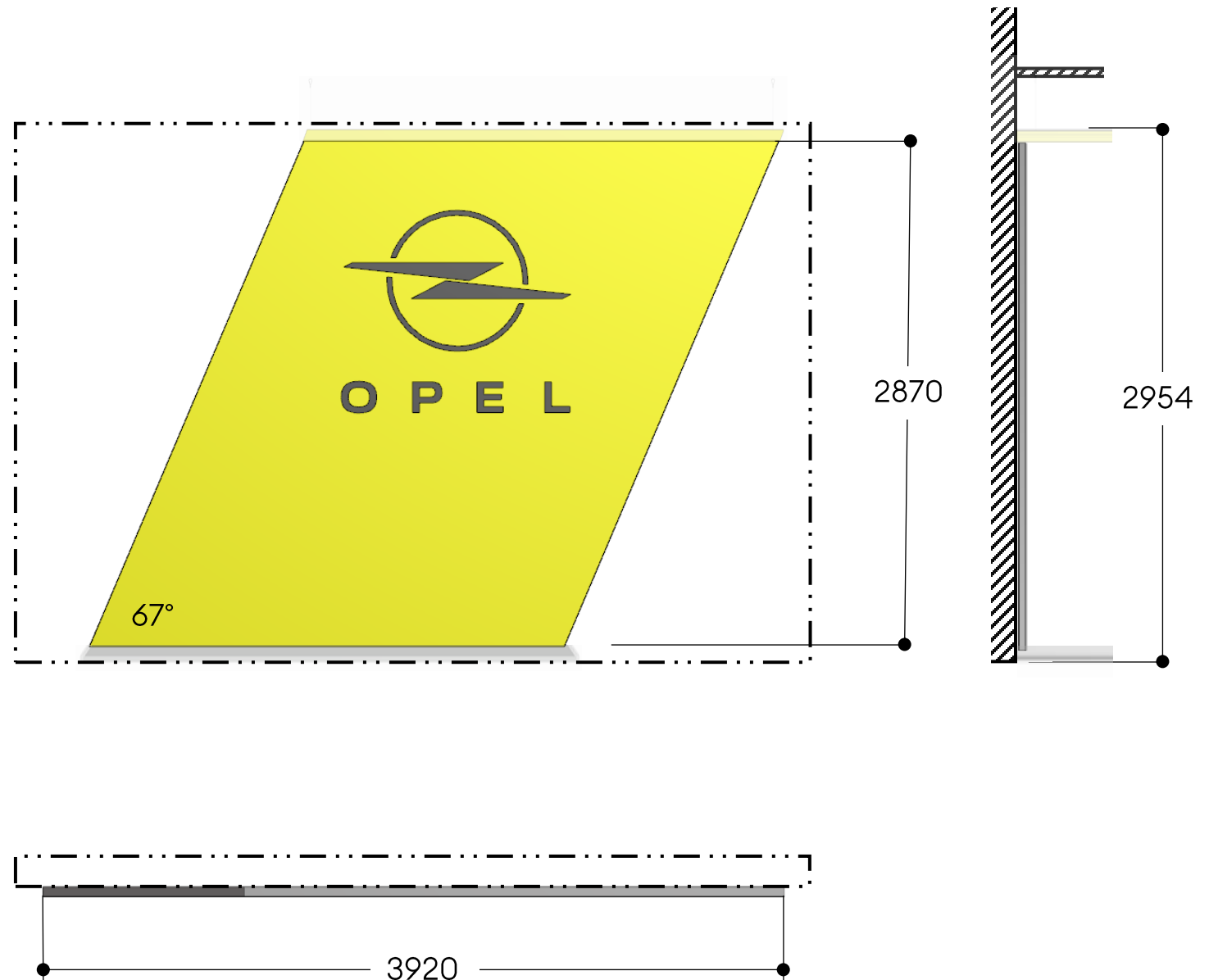

# Yellow Ceilling Module L

- **ST-I-OPL05D1**
- **8004910**

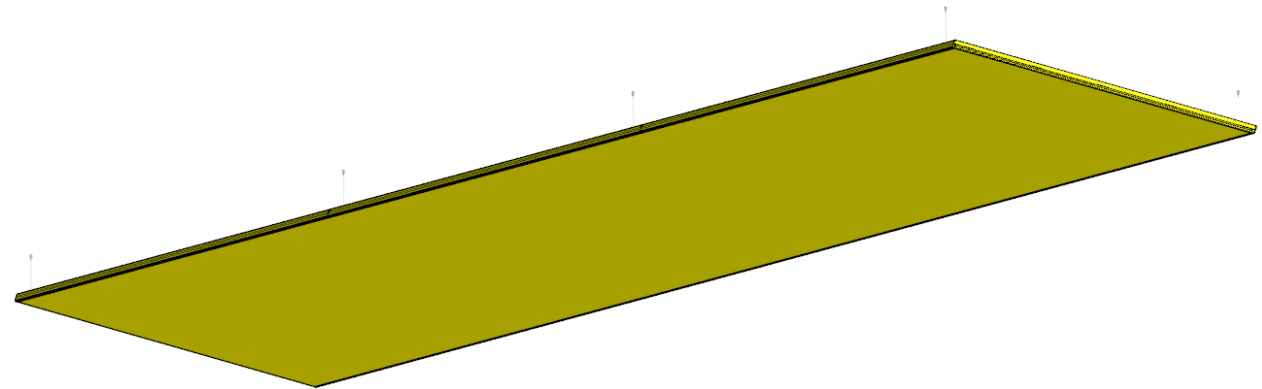

Dimensions : 8135x2719x54

Weight : 60 Kg

Electrical connection : None

Mounting position :Ceiling

# Yellow Ceiling Module L

## Requirements before installation

- The ceiling must be reinforced according to the weight specification of the article.
- Each suspension point must be able to bear a load of at least 20 kg.

## to observe

- Positioning Pedestal modules, Slash and Ceiling modules are interdependent.
- module is visible from above. A facing is recommended for multi-storey showrooms. This is not included in the costs.

## Explanation of symbols

- ⋯ Ceiling reinforcement
- Ceiling fixing points

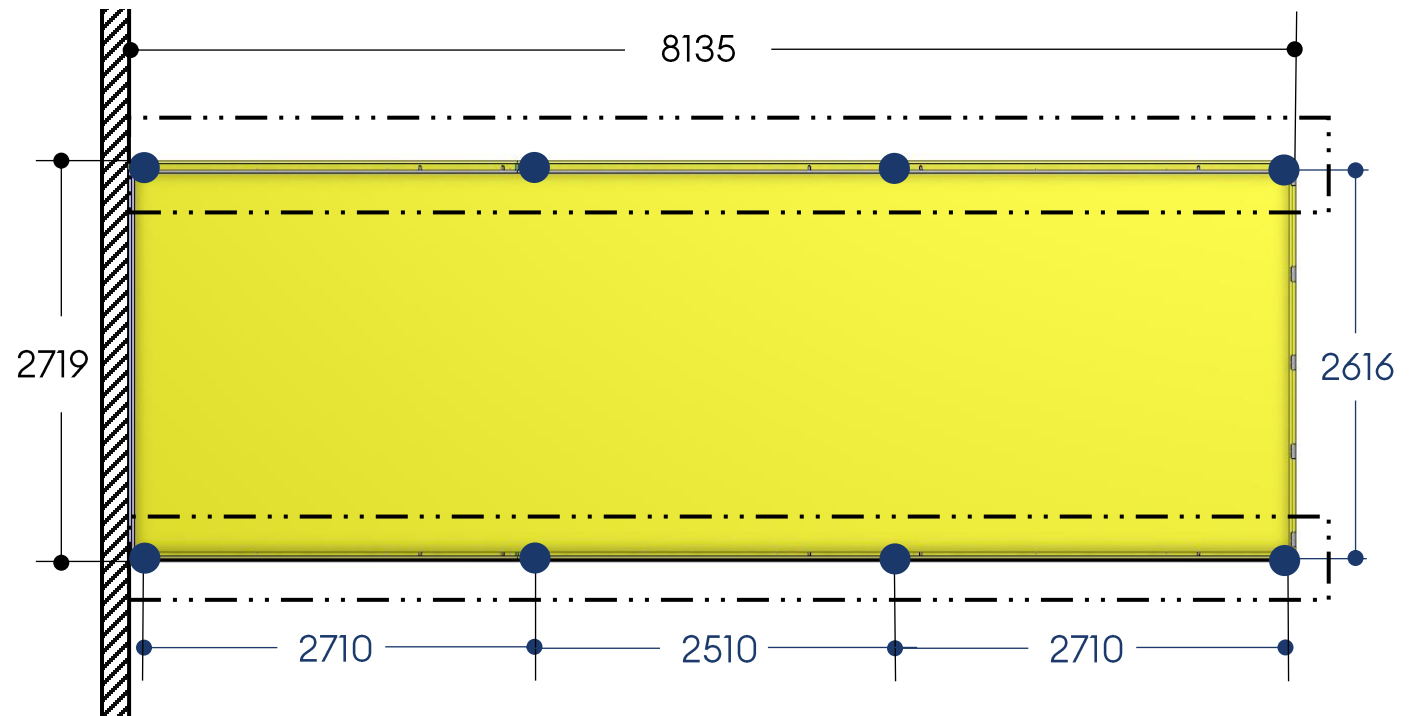
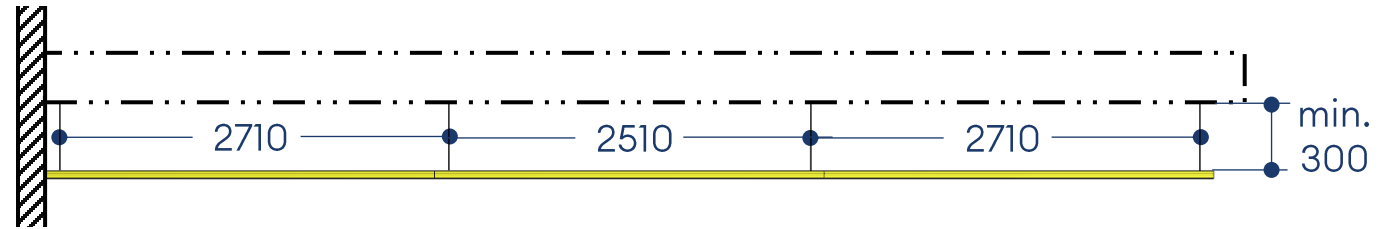

# Yellow Ceiling Module M

- **ST-I-OPL05D2**
- **8006084**

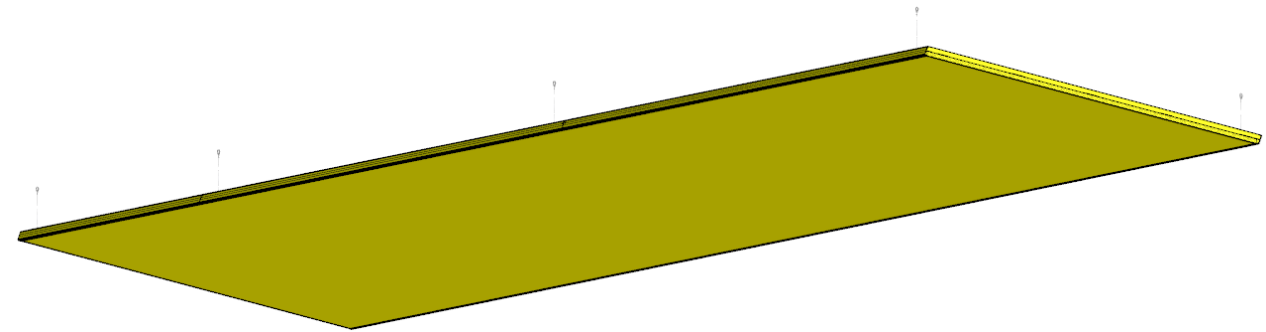

Dimensions : 6780x2719x54

Weight : 50 Kg

Electrical connection : None

Mounting position :Ceiling

# Yellow Ceiling Module M

## Requirements before installation

- The ceiling must be reinforced according to the weight specification of the article.
- Each suspension point must be able to bear a load of at least 20 kg.

## to observe

- Positioning Pedestal modules, Slash and Ceiling modules are interdependent.
- module is visible from above. A facing is recommended for multi-storey showrooms. This is not included in the costs.

## Explanation of symbols

- ☐--- Ceiling reinforcement
- Ceiling fixing points

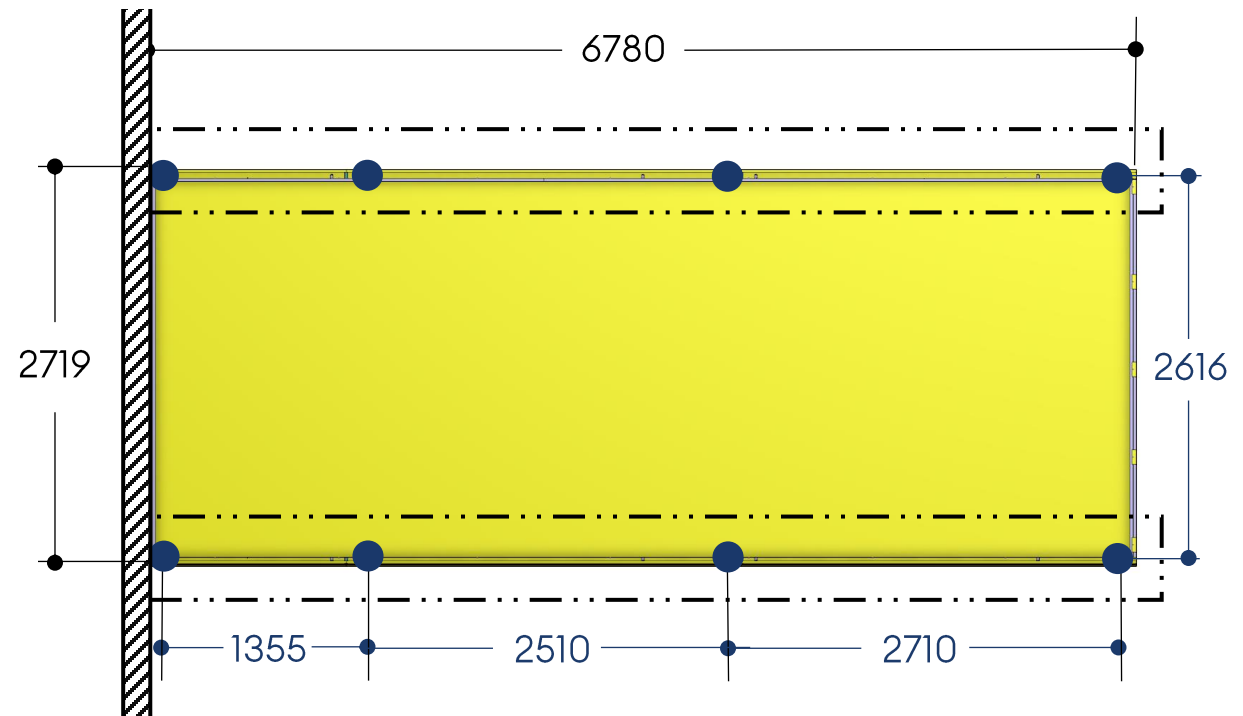
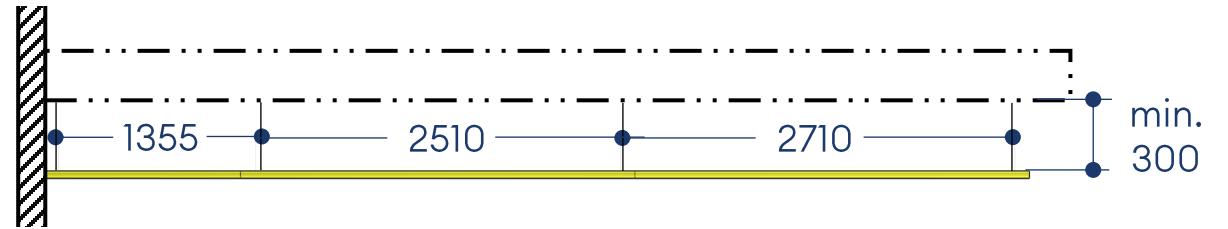

# Yellow Ceiling Module S

- **ST-I-OPL05D3**
- **8006064**

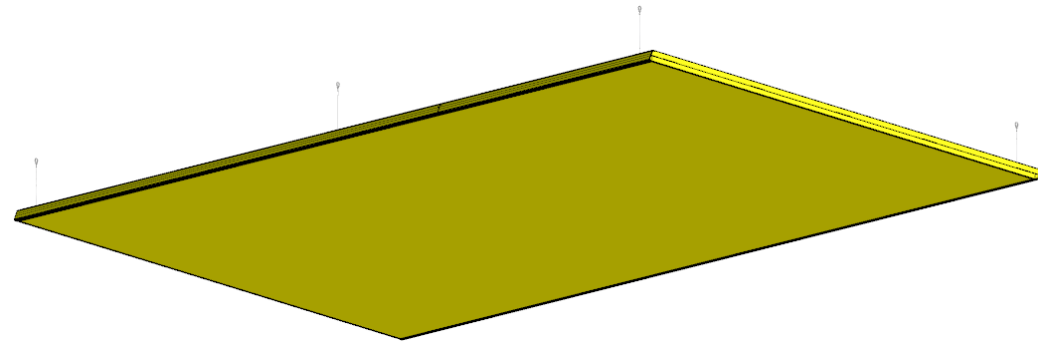

Dimensions : 4070x2719x54

Weight : 35 Kg

Electrical connection : None

Mounting position :Ceiling

# Yellow Ceiling Module S

## Requirements before installation

- The ceiling must be reinforced according to the weight specification of the article.
- Each suspension point must be able to bear a load of at least 20 kg.

## to observe

- Positioning Pedestal modules, Slash and Ceiling modules are interdependent.
- module is visible from above. A facing is recommended for multi-storey showrooms. This is not included in the costs.

## Explanation of symbols

- ☐--- Ceiling reinforcement
- Ceiling fixing points

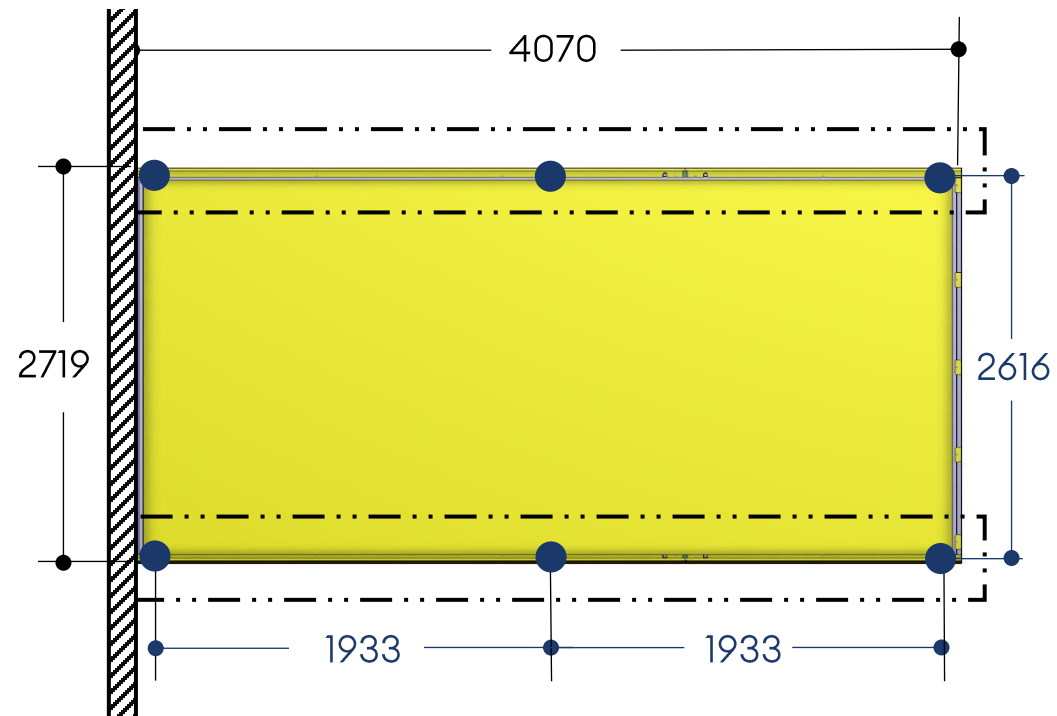
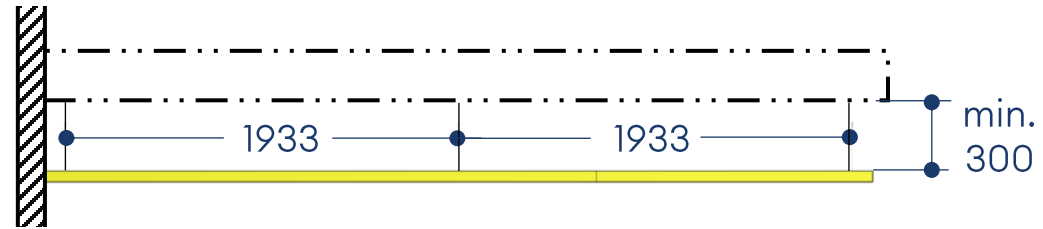

# Yellow Ceiling Module XS

- **ST-I-OPL5D4**
- **8006077**

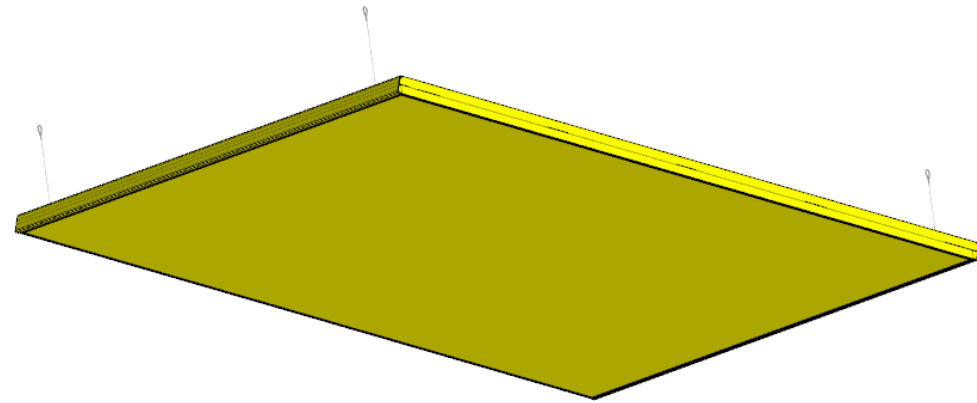

Dimensions : 2718x2719x54

Weight : 23 Kg

Electrical connection : None

Mounting position :Ceiling



# Yellow Ceiling Module XS

## Requirements before installation

- The ceiling must be reinforced according to the weight specification of the article.
- Each suspension point must be able to bear a load of at least 20 kg.

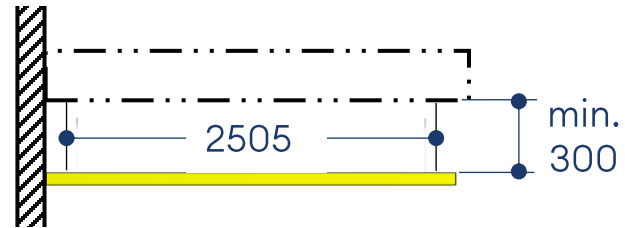

## to observe

- Positioning Pedestal modules, Slash and Ceiling modules are interdependent.
- module is visible from above. A facing is recommended for multi-storey showrooms. This is not included in the costs.

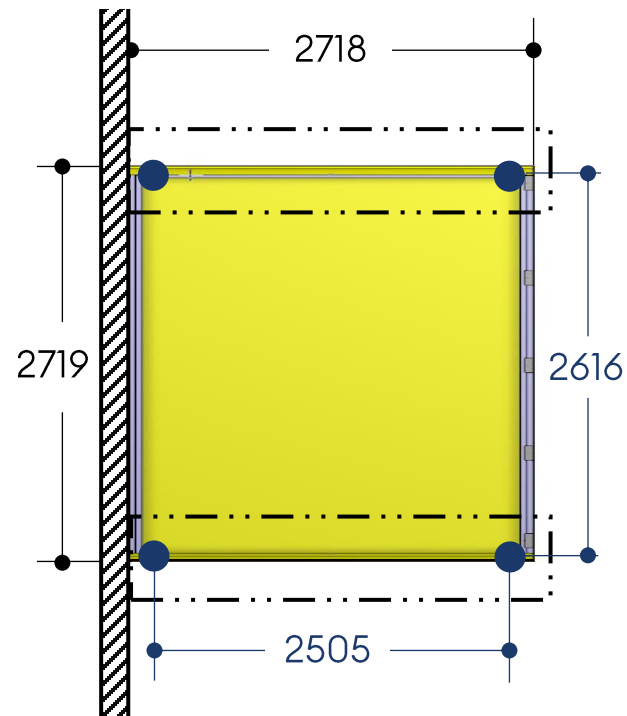

## Explanation of symbols

- ☐...☐ Ceiling reinforcement
- Ceiling fixing points

# Yellow Podest Module L

- **ST-I-OPL05F1**
- **8003867**

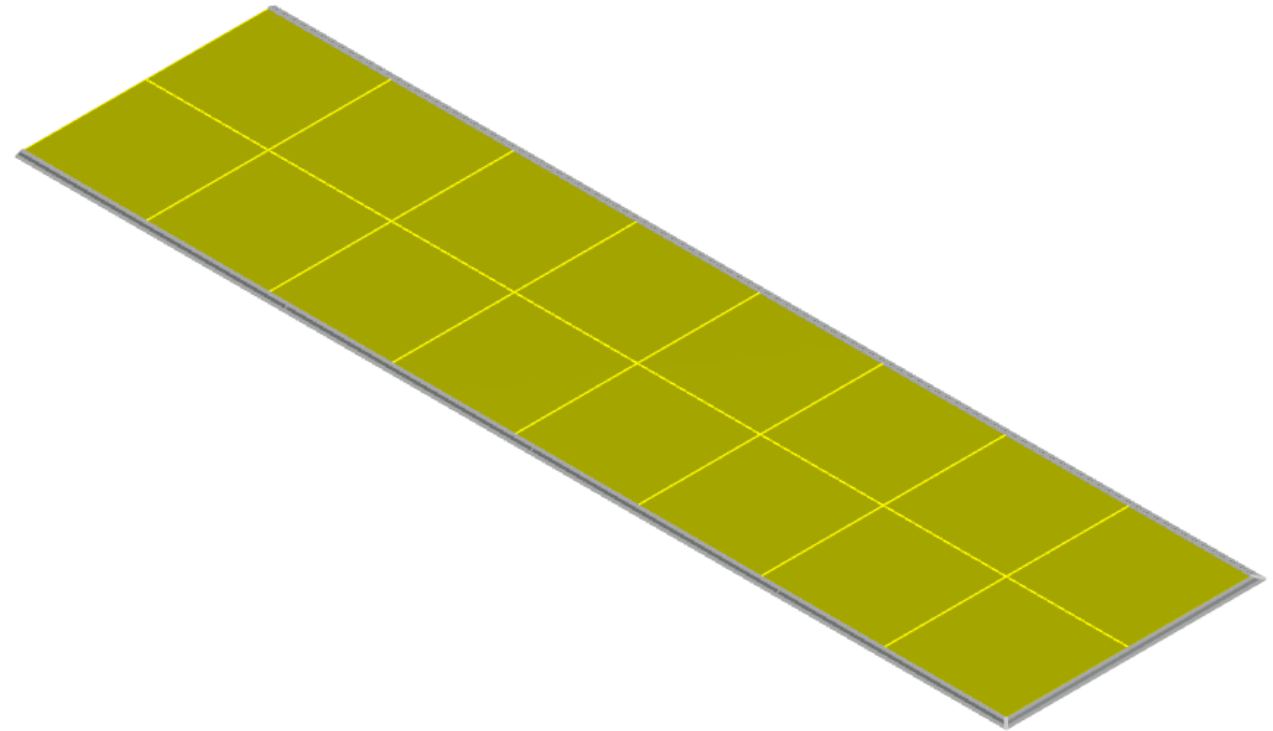

Dimensions : 10915x2860x32  
Weight : 1000 Kg  
Electrical connection : None  
Mounting position : Floor

# Yellow Pedest Module L

## Requirements before installation

- The floor must be reinforced according to the weight specification of the article.

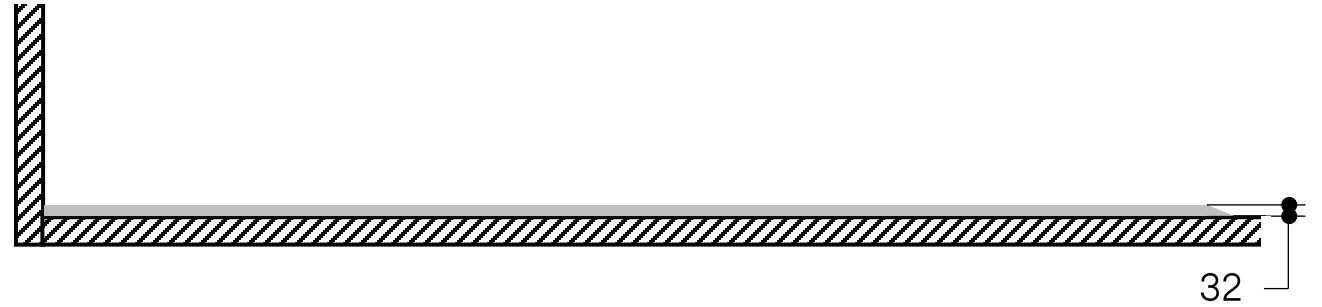

## to observe

- Positioning Pedestal modules, Slash and Ceiling modules are interdependent.
- Sealing the fields together
- Sealing fields & end frames
- Sealing frame & floor

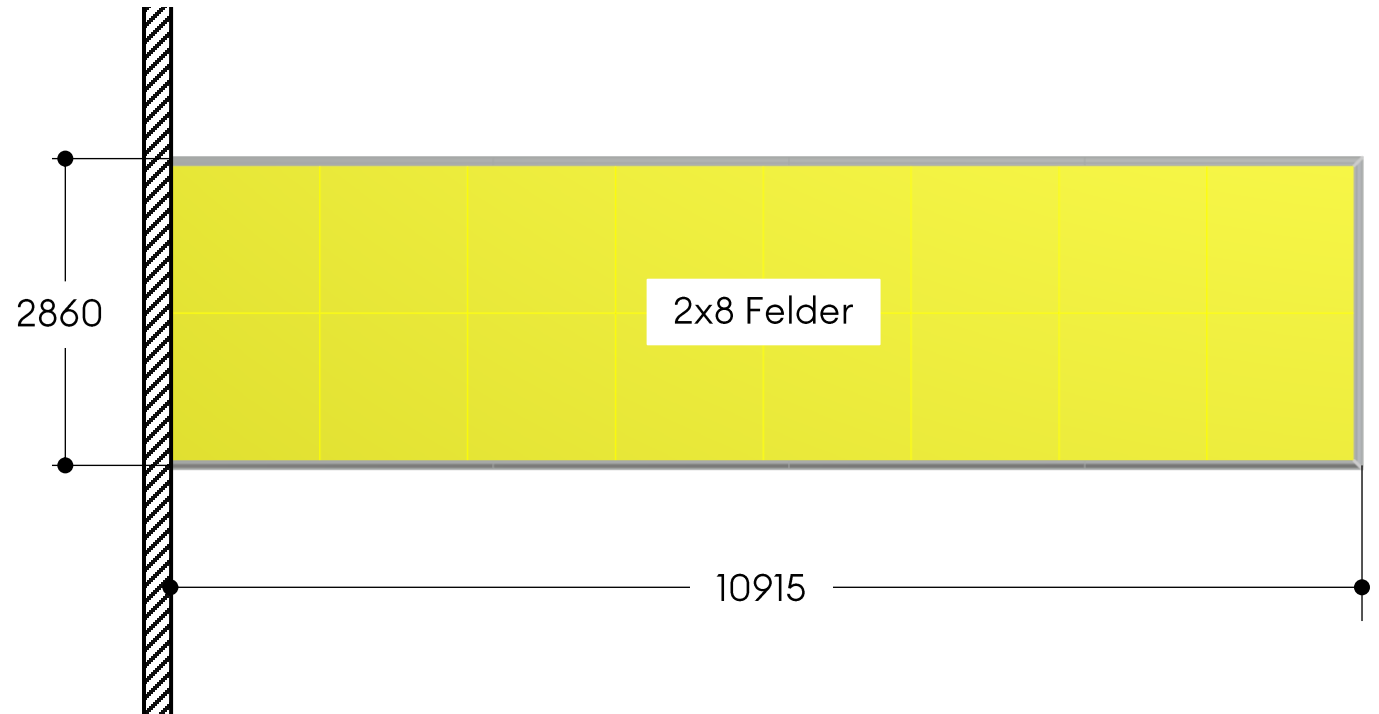

# Yellow Podest Module M

- **ST-I-OPL05F2**
- **8003868**

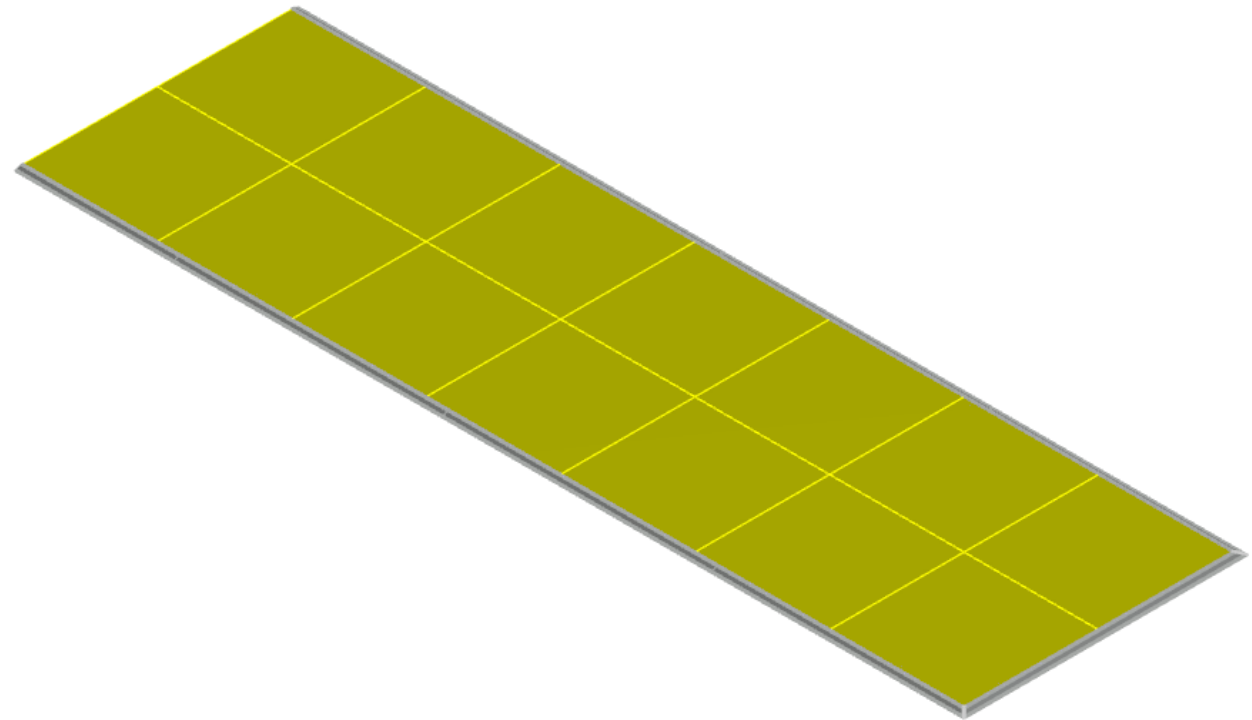

Dimensions : 9560x2860x32

Weight : 870 Kg

Electrical connection : None

Mounting position : Floor

# Yellow Pedest Module M

## Requirements before installation

- The floor must be reinforced according to the weight specification of the article.

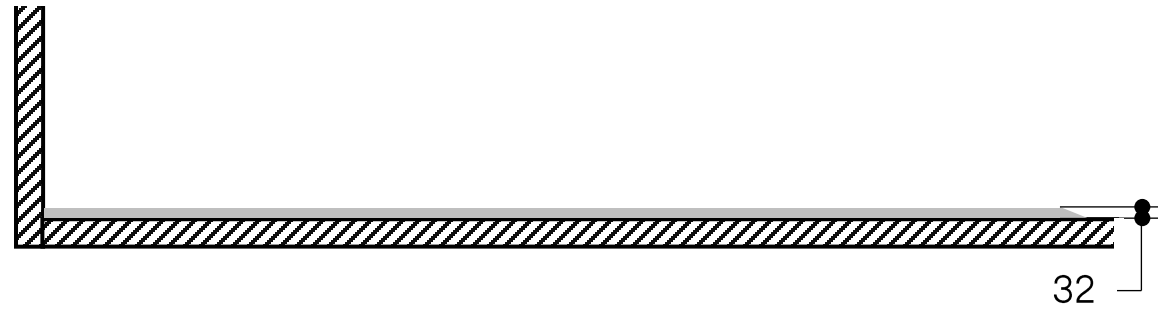

## to observe

- Positioning Pedestal modules, Slash and Ceiling modules are interdependent.
- Sealing the fields together
- Sealing fields & end frames
- Sealing frame & floor

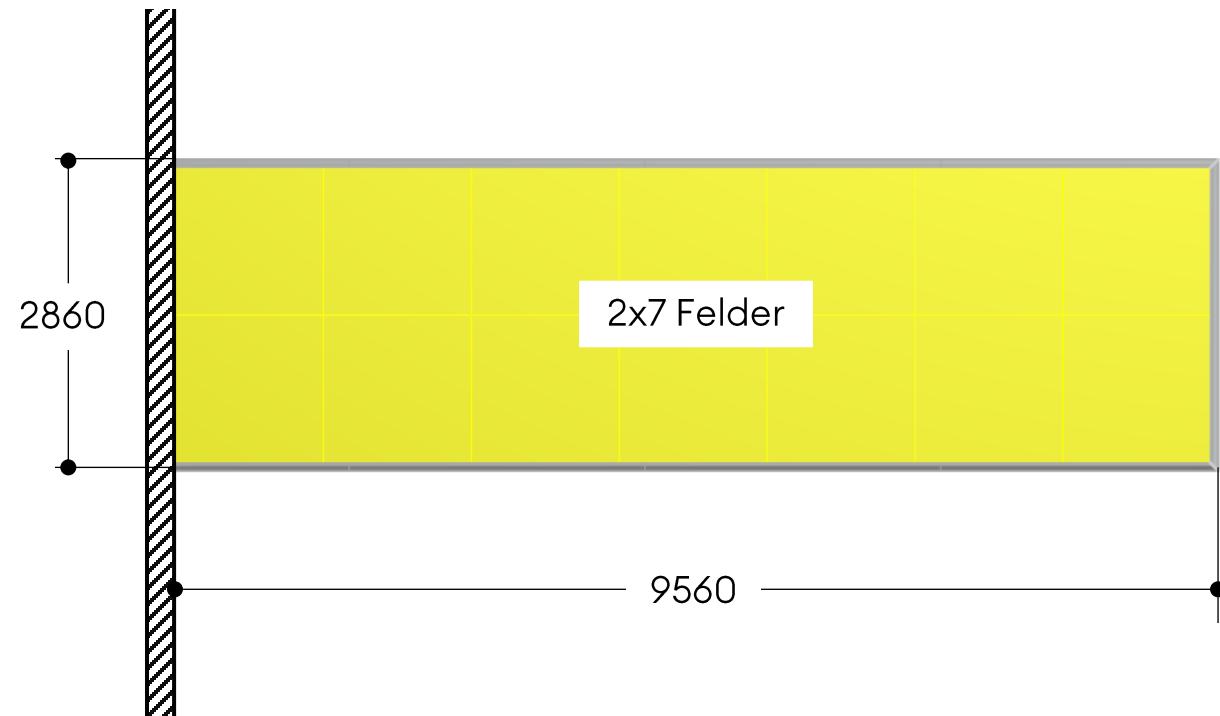

# Yellow Podest Module S

- **ST-I-OPL05F3**
- **8003869**

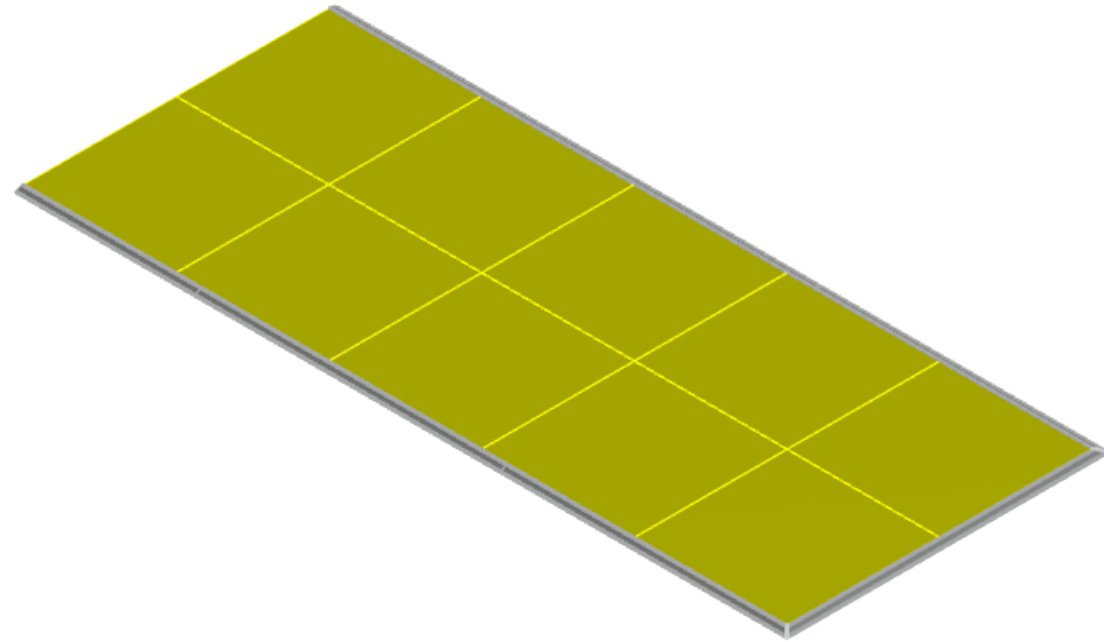

Dimensions : 6850x2860x32  
Weight : 620 Kg  
Electrical connection : None  
Mounting position : Floor

# Yellow Pedest Module S

## Requirements before installation

- The floor must be reinforced according to the weight specification of the article.

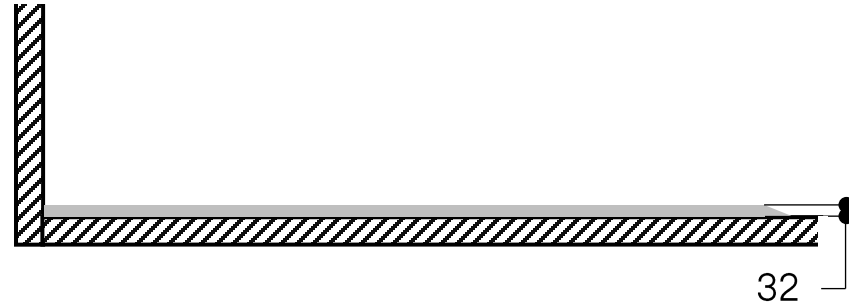

## to observe

- Positioning Pedestal modules, Slash and Ceiling modules are interdependent.
- Sealing the fields together
- Sealing fields & end frames
- Sealing frame & floor

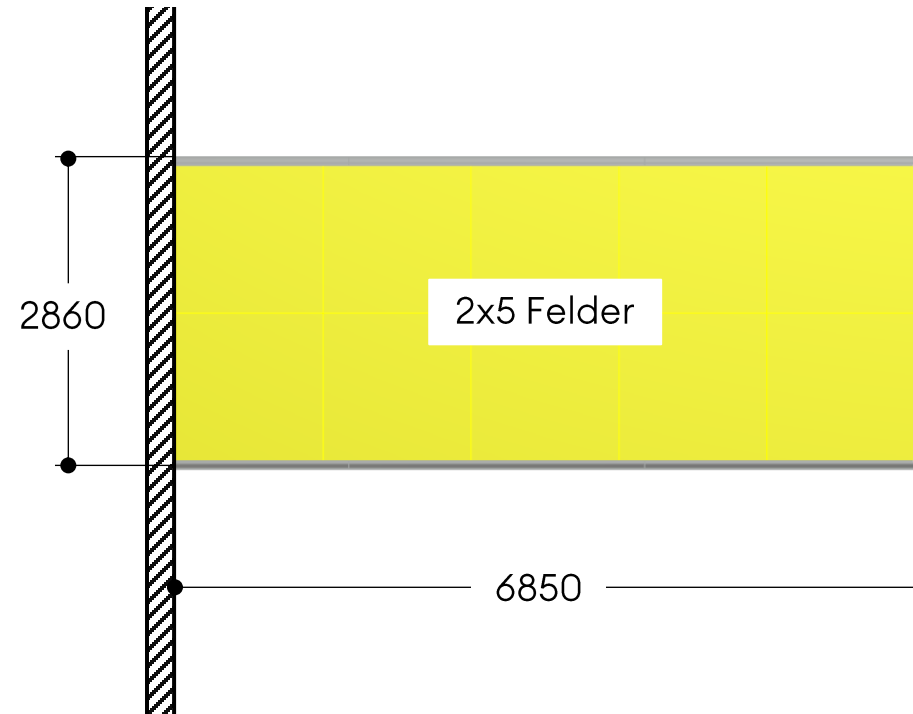

# Yellow Podest Module XS

- **ST-I-OPL05F4**
- **8006871**

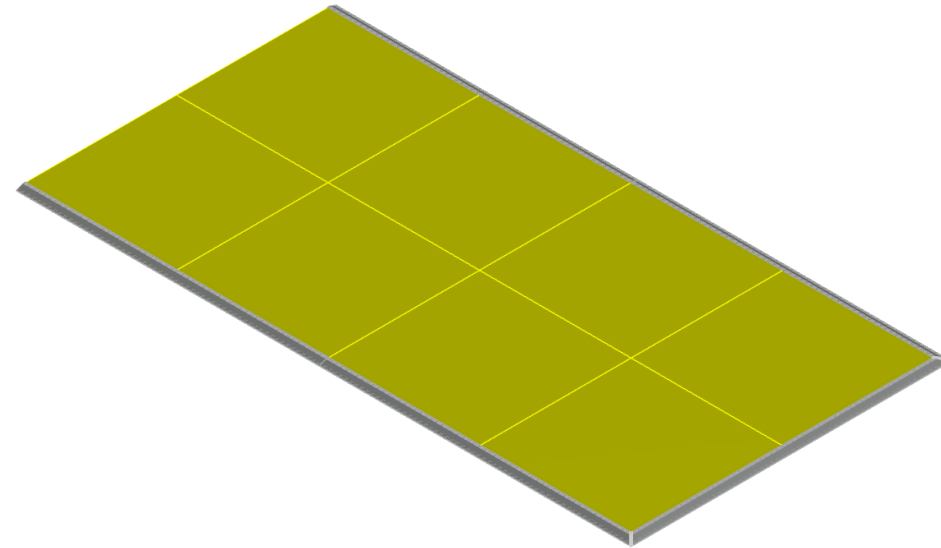

Dimensions : 5495x2860x32  
Weight : 500 Kg  
Electrical connection : None  
Mounting position : Floor



# Yellow Pedest Module XS

## Requirements before installation

- The floor must be reinforced according to the weight specification of the article.

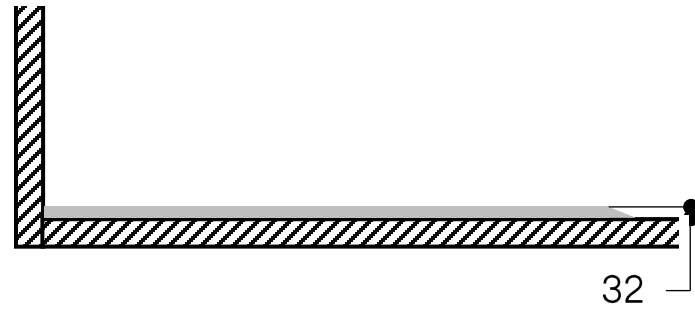

## to observe

- Positioning Pedestal modules, Slash and Ceiling modules are interdependent.
- Sealing the fields together
- Sealing fields & end frames
- Sealing frame & floor

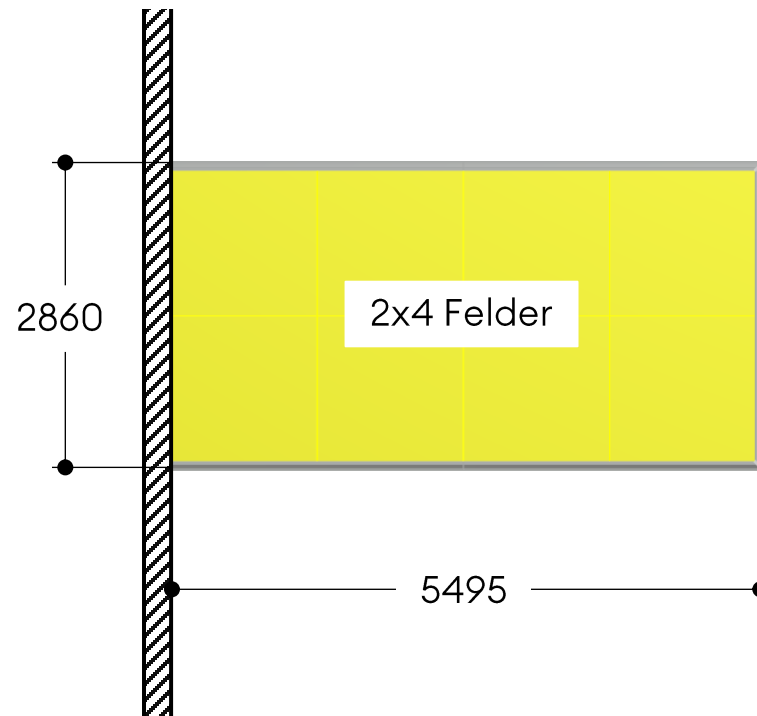

“

Thank you